

Ampex

SVT-3 PRO

Bass Guitar Amplifier



Owner's Manual



TABLE OF CONTENTS

Important Safety Instructions.....	2-3
Introduction / Features.....	4
The Front Panel.....	5-7
The Rear Panel.....	8-9
Suggested Settings.....	10
Personal Settings.....	11
Rack Mounting / Thermal Considerations.....	12
Block Diagram.....	13
Technical Specifications.....	14
Troubleshooting / Service Information.....	15

IMPORTANT SAFETY INSTRUCTIONS

1. Read these instructions.
2. Keep these instructions.
3. Heed all warnings.
4. Follow all instructions.
5. Do not use this apparatus near water.
6. Clean only with a dry cloth.
7. Do not block any ventilation openings. Install in accordance with the manufacturer's instructions.
8. Do not install near any heat sources such as radiators, heat registers, stoves, or other apparatus (including amplifiers) that produce heat.
9. Do not defeat the safety purpose of the polarized or grounding-type plug. A polarized plug has two blades with one wider than the other. A grounding-type plug has two blades and a third grounding prong. The wide blade or the third prong are provided for your safety. If the provided plug does not fit into your outlet, consult an electrician for replacement of the obsolete outlet.
10. Protect the power cord from being walked on or pinched particularly at plugs, convenience receptacles, and the point where they exit from the apparatus.
11. Only use attachments/accessories specified by the manufacturer.
12. Use only with a cart, stand, tripod, bracket, or table specified by the manufacturer, or sold with the apparatus. When a cart is used, use caution when moving the cart/apparatus combination to avoid injury from tip-over.
13. Unplug this apparatus during lightning storms or when unused for long periods of time.
14. Refer all servicing to qualified service personnel. Servicing is required when the apparatus has been damaged in any way, such as



power-supply cord or plug is damaged, liquid has been spilled or objects have fallen into the apparatus, the apparatus has been exposed to rain or moisture, does not operate normally, or has been dropped.

15. Do not overload wall outlets and extension cords as this can result in a risk of fire or electric shock.

16. This apparatus shall not be exposed to dripping or splashing, and no object filled with liquids, such as vases or beer glasses, shall be placed on the apparatus.

17. This apparatus has been designed with Class-I construction and must be connected to a mains socket outlet with a protective earthing connection (the third grounding prong).

18. The MAINS plug or an appliance coupler is used as the disconnect device, so the disconnect device shall remain readily operable.

19. For the terminals marked with symbol of "⚡" may be of sufficient magnitude to constitute a risk of electric shock. The external wiring connected to the terminals requires installation by an instructed person or the used of ready-made leads or cords.

	CAUTION AVIS RISK OF ELECTRIC SHOCK. DO NOT OPEN RISQUE DE CHOC ELECTRIQUE. NE PAS OUVRIIR	
<small>CAUTION: TO REDUCE THE RISK OF ELECTRIC SHOCK DO NOT REMOVE COVER (OR BACK) NO USER-SERVICEABLE PARTS INSIDE. REFER SERVICING TO QUALIFIED PERSONNEL. ATTENTION: POUR EVITER LES RISQUES DE CHOC ELECTRIQUE, NE PAS ENLEVER LE COUVERCLE. AUCUN ENTRETIEN DE PIECES INTERIEURES PAR L'USAGER. CONFIER L'ENTRETIEN AU PERSONNEL QUALIFIE. AVIS: POUR EVITER LES RISQUES D'INCENDIE OU D'ELECTROCUTION, N'EXPOSEZ PAS CET ARTICLE A LA PLUIE OU A L'HUMIDITE</small>		



The lightning flash with arrowhead symbol within an equilateral triangle is intended to alert the user to the presence of uninsulated "dangerous voltage" within the product's enclosure, that may be of sufficient magnitude to constitute a risk of electric shock to persons.

Le symbole éclair avec point de flèche à l'intérieur d'un triangle équilatéral est utilisé pour alerter l'utilisateur de la présence à l'intérieur du coffret de "voltage dangereux" non isolé d'ampleur suffisante pour constituer un risque d'électrocution.



The exclamation point within an equilateral triangle is intended to alert the user of the presence of important operating and maintenance (servicing) instructions in the literature accompanying the appliance.
Le point d'exclamation à l'intérieur d'un triangle équilatéral est employé pour alerter les utilisateurs de la présence d'instructions importantes pour le fonctionnement et l'entretien (service) dans le livret d'instruction accompagnant l'appareil.

WARNING — To reduce the risk of fire or electric shock, do not expose this apparatus to rain or moisture.



NOTE: This equipment has been tested and found to comply with the limits for a Class B digital device, pursuant to part 15 of the FCC Rules. These limits are designed to provide reasonable protection against harmful interference in a residential installation. This equipment generates, uses, and can radiate radio frequency energy and, if not installed and used in accordance with the instructions, may cause harmful interference to radio communications. However, there is no guarantee that interference will not occur in a particular installation. If this equipment does cause harmful interference to radio or television reception, which can be determined by turning the equipment off and on, the user is encouraged to try to correct the interference by one or more of the following measures:

- Reorient or relocate the receiving antenna.
- Increase the separation between the equipment and the receiver.
- Connect the equipment into an outlet on a circuit different from that to which the receiver is connected.
- Consult the dealer or an experienced radio/TV technician for help.

CAUTION: Changes or modifications to this device not expressly approved by LOUD Technologies Inc. could void the user's authority to operate the equipment under FCC rules.

This apparatus does not exceed the Class A/Class B (whichever is applicable) limits for radio noise emissions from digital apparatus as set out in the radio interference regulations of the Canadian Department of Communications.

CONSIGNES DE SECURITE IMPORTANTES

- LIRE, SUIVRE TOUTES LES INSTRUCTIONS ET LES PRECAUTIONS D'UTILISATION
- NE PAS UTILISER PROCHE D'UNE SOURCE DE CHALEUR ET NE PAS BLOQUER OU OBSTRUER LE SYSTEME DE VENTILATION SUR CET APPAREIL. POUR UNE UTILISATION CONFORME, CET APPAREIL NECESSITE ENVIRON 7CM D'ESPACE BIEN VENTILE AUTOUR DE SON SYSTEME DE REFROIDISSEMENT, AINSI QU'UN COURANT D'AIR FRAIS CONSTANT
- NE PAS UTILISER CET APPAREIL PROCHE D'UNE SOURCE LIQUIDE
- NETTOYER SEULEMENT A L'AIDE D'UN CHIFFON DOUX ET SEC ET NE PAS UTILISER DE PRODUITS MENAGERS
- CONNECTER UNIQUEMENT LE CABLE D'ALIMENTATION FOURNI SUR UNE PRISE AVEC MISE A LA TERRE, ET COMPATIBLE AVEC LA TENSION, L'INTENSITE ET LA FREQUENCE REQUISES INDIQUEES SUR LA FACE ARRIERE DE L'APPAREIL
- S'ASSURER DE NE PAS MARCHER, PLIER OU TIRER SUR LE CABLE D'ALIMENTATION
- DEBRANCHER L'APPAREIL LORS D'UNE TEMPETE OU LORS D'UNE TRES LONGUE PERIODE DE NON UTILISATION
- UTILISER UNIQUEMENT DES ACCESSOIRES SPECIFIES PAR LE FABRICANT POUR UNE UTILISATION EN TOUTE SECURITE ET POUR EVITER DES BLESSURES
- **ATTENTION:** AFIN DE PREVENIR TOUT RISQUE DE CHOC ELECTRIQUES OU DE DEBUT D'INCENDIE, NE PAS EXPOSER CET APPAREIL A LA PLUIE ET A L'HUMIDITE
- TOUT ENTRETIEN DOIT ETRE FAIT PAR UN TECHNICIEN QUALIFIE
- NOS AMPLIFICATEURS PEUVENT PRODUIRE DE TRES HAUTES PRESSIONS ACOUSTIQUES QUI PEUVENT CAUSER DES DOMMAGES AUDITIFS PERMANENTS OU DEFINITIFS. L'UTILISER AVEC UNE GRANDE PRECAUTION EST CONSEILLE ET DES PROTECTIONS AUDITIVES SONT RECOMMANDEES POUR UNE UTILISATION A FORT VOLUME.
- **ATTENTION:** CET APPAREIL REQUIERT UNE PRISE MURALE AVEC MISE A LA TERRE, AUX NORMES ACTUELLES ET COMPATIBLE AVEC LES SPECIFICATIONS ELECTRIQUES SE TROUVANT EN FACE ARRIERE DE L'APPAREIL. LA PRISE ELECTRIQUE DOIT ETRE NORMES ACCESSIBLE POUR DEBRANCHER L'APPAREIL EN CAS DE DEFAUT PENDANT L'UTILISATION
- CET APPAREIL DOIT ETRE DEBRANCHE SI IL N'EST PAS UTILISE

Elimination correcte du produit : Ce symbole indique que ce produit ne doit pas être éliminé avec les ordures ménagères, comme le prévoit la directive WEEE (2002/96/EC) et votre loi nationale.

Ce produit doit être remis à un site de recyclage des déchets électriques et des équipements électroniques (EEE).

Un mauvais recyclage de ce type de déchet peut avoir de possibles impacts négatifs sur l'environnement et la santé humaine dus aux émanations de substances.

Dans un même temps, votre coopération à un recyclage correct de ce produit contribuera à la bonne utilisation des ressources naturelles.

Pour connaître l'endroit où il est possible de recycler ces équipements, merci de contacter votre mairie, les services de recyclages ou le service des déchets ménagers.



Correct disposal of this product: This symbol indicates that this product should not be disposed of with your household waste, according to the WEEE directive (2002/96/EC) and your national law. This product should be handed over to an authorized collection site for recycling waste electrical and electronic equipment (EEE). Improper handling of this type of waste could have a possible negative impact on the environment and human health due to potentially hazardous substances that are generally associated with EEE. At the same time, your cooperation in the correct disposal of this product will contribute to the effective usage of natural resources. For more information about where you can drop off your waste equipment for recycling, please contact your local city office, waste authority, or your household waste disposal service.

ATTENTION — Le présent appareil numérique n'émet pas de bruits radioélectriques dépassant les limites applicables aux appareils numériques de class A/de class B (selon le cas) prescrites dans le règlement sur le brouillage radioélectrique édicté par les ministere des communications du Canada.

Exposure to extremely high noise levels may cause permanent hearing loss. Individuals vary considerably in susceptibility to noise-induced hearing loss, but nearly everyone will lose some hearing if exposed to sufficiently intense noise for a period of time. The U.S. Government's Occupational Safety and Health Administration (OSHA) has specified the permissible noise level exposures shown in the following chart.

According to OSHA, any exposure in excess of these permissible limits could result in some hearing loss. To ensure against potentially dangerous exposure to high sound pressure levels, it is recommended that all persons exposed to equipment capable of producing high sound pressure levels use hearing protectors while the equipment is in operation. Ear plugs or protectors in the ear canals or over the ears must be worn when operating the equipment in order to prevent permanent hearing loss if exposure is in excess of the limits set forth here:

Duration, per day in hours	Sound Level dBA, Slow Response	Typical Example
8	90	Duo in small club
6	92	
4	95	Subway Train
3	97	
2	100	Very loud classical music
1.5	102	
1	105	The boss screaming at his minions about manual deadlines
0.5	110	
0.25 or less	115	Loudest parts of a rock concert



Introduction

Congratulations! You are now the proud owner of an Ampeg SVT-3 PRO bass guitar amplifier. This compact, yet dynamically powerful bass amplifier, delivers a searing 450 watts of unsurpassed quality, offering the classic vibrance of tubes, as well as contemporary features.

The SVT-3 PRO amplifier is an ideal companion to the Classic Series, Pro Series, or PF cabinets, available separately.

Like all Ampeg products, your SVT-3 PRO amplifier is designed by musicians and built using only the best of components. Each amplifier is tested to confirm that it meets our specifications, and we believe that this amplifier is the absolute best that it can be. In order to get the most out of your new amplifier, please read this manual before you begin playing.

Best of luck in all of your musical endeavors!

Sincerely,

The dedicated team at Ampeg

Features

Here are some of the features packed into your new amplifier:

- **5-POSITION MIDRANGE SELECTOR:** Take your pick from the five center frequency points available to get just the right midrange voice [page 5].
- **TUBE GAIN:** Control the dynamics of tonal response characteristics from the power amp; from punch to compressed [page 6].
- **9-BAND GRAPHIC EQ:** Use as a “second channel” for bass solos, or to shape the sound to your own exacting standards. An independent level control allows you to adjust the Graphic EQ volume [page 6-7].
- **TRANSFORMER BALANCED LINE OUTPUTS:** Independent level control. One balanced XLR and one balanced/unbalanced 1/4" jack to patch into house consoles, mixing boards, or external power amplifiers [page 8].
- **EFFECTS LOOP:** Connect effects here for increased intensity and quieter operation [page 9].
- **POWER AMP IN AND PREAMP OUT:** A separate preamp may be connected to the Power Amp In jack and the Preamp Out jack may be connected to a slave amp [page 9].



The Front Panel

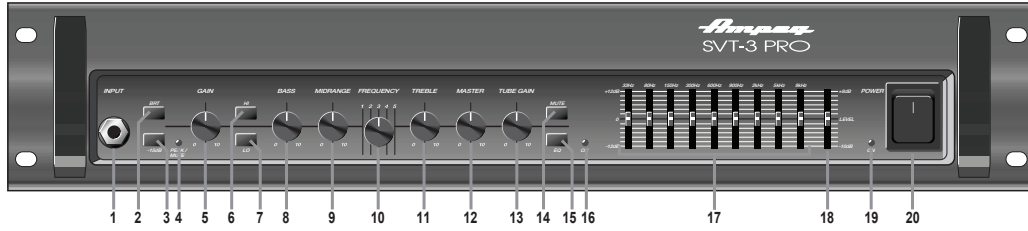

- 1. INPUT:** The signal output from an instrument (active or passive) may be connected to this 1/4" input by means of a shielded instrument cable.
- 2. BRIGHT:** When this switch is engaged, a more lively top end response [+6 dB at 2 kHz] is added to the input signal.
- 3. -15 dB:** Press this switch in to reduce the input signal by 15 dB and compensate for higher output sources. This attenuation is suited for use with basses that have active electronics or high-output pickups. Use this pad if you notice that the peak/mute LED comes on regularly. It will reduce the chance of overdriving the preamplifier stage and allow more usable range and fine adjustment of the gain control.
- 4. PEAK/MUTE LED:** This red warning LED will come on if: the mute switch is engaged, or if the input signal is too high, the gain control is set too high, or there is too much boost from the bass, midrange and treble controls. If it comes on regularly, even when these controls are low, try engaging the -15 dB pad.
- 5. GAIN:** This varies the amount of signal driving the preamplifier. If a small clockwise rotation from minimum leads to overloading and the peak LED illuminating, try engaging the -15 dB pad. This will give more usable range with the gain control.
- 6. ULTRA HI:** This switch, when engaged, enhances the amount of high frequency output by 6 dB at 5 kHz.
- 7. ULTRA LO:** This switch, when engaged, enhances the amount of low-end output by 2 dB at 40 Hz and -10 dB cut at 500 Hz.
- 8. BASS:** Use this to adjust the low frequency level of the amplifier. This provides up to 12 dB of boost, or 12 dB of cut at 50 Hz. The low frequency output is flat at the center position.
- 9. MIDRANGE:** Use this to adjust the midrange frequency level of the amplifier. This provides up to 15 dB of boost, or 15 dB of cut at the center frequency selected by the frequency control. The midrange frequency output is flat at the center position. Rotate the control counter clockwise for a "contoured" sound (more distant, less midrange output) or clockwise for a sound which really cuts through.
- 10. FREQUENCY:** This control allows you to select the center frequency for the midrange control, giving you a choice of five "voices" for the midrange. The numbers correspond to the following center frequencies: 1=220 Hz, 2=450 Hz, 3=800 Hz, 4=1.6 kHz, 5=3 kHz.



The Front Panel continued

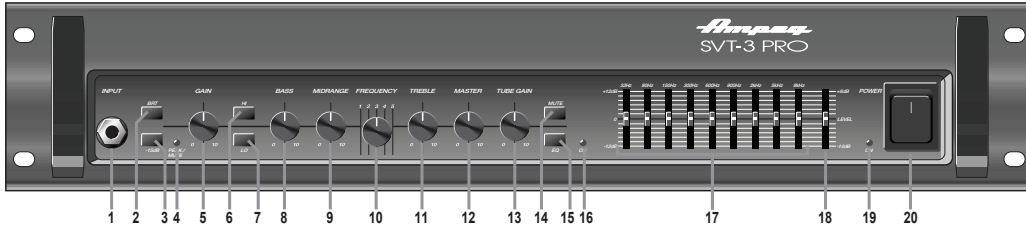

11. TREBLE: Use this to adjust the high frequency level of the amplifier. This provides up to 14 dB of boost, or 19 dB of cut at 5 kHz. The high frequency output is flat at the center position.

12. MASTER: Use this to control the overall output level. Use it wisely and turn it down when making connections or trying something new.

13. TUBE GAIN: The tube gain control varies the high voltage supply to the preamp tubes. This allows a variety of tonal response characteristics from the power amp and replaces the limiter found on typical solid state power amps. At "10" the voltage is at maximum, providing a dynamic, highly responsive tone. At "0" the voltage is at minimum, offering a thickened, more compressed tone. This tone may also be distorted, depending on volume level. In between settings are best for preventing harsh distortion when driving the power amp to its limits. The effect of this control increases from moderate to dramatic as the power amp is driven harder.

NOTE: When adjusting the tube gain control from "10" to "0" rapidly, a low frequency hum and muting of the output signal occur simultaneously. This is due to shifting of the DC bias point of the tubes and is no cause for concern. Adjusting the control quickly from "0" to "10" brings a moderate delay due to the power supply capacitors charging.

14. MUTE: Press this switch in to mute all outputs except the tuner out. The footswitch may also control muting if the mute switch on the front panel is left in the "out" position. (The front panel switch is still active with the footswitch connected. This is excellent for tuning your bass with an electric tuner without having to adjust any levels to turn down the sound). The peak/mute LED will illuminate when this switch is engaged.

15. GRAPHIC EQ: When this switch is engaged, the 9-band graphic EQ is enabled. A footswitch overrides this switch.



The Front Panel continued

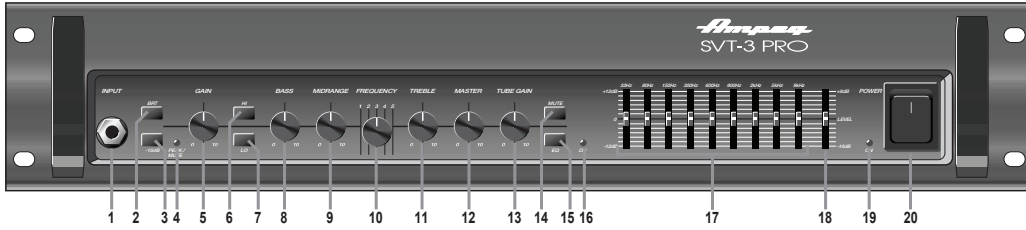

16. ACTIVE LED: This LED illuminates when the EQ is on.

17. 9-BAND GRAPHIC EQ: These sliders control the output frequencies indicated above each control. The center position of each control is flat [no boost or cut].

18. LEVEL: This slider is the output volume control for the Graphic EQ and only affects the signal when the EQ is engaged. If the EQ'd signal is too soft, slide the level control up; if it's too loud, slide this control down.

19. ON LED: This LED illuminates when the power is on.

20. POWER SWITCH: Use this switch to turn the overall system power on or off. Press the top of the switch to turn on the power. Press the bottom of this switch to put the amp into standby mode. It will not function, but the circuits are still live. To remove AC power, either turn off the AC mains supply, or unplug the power cord from the amplifier and the AC mains supply.

NOTE: There is a delay during power up until the protection relay enables the power amplifier output.



The Rear Panel

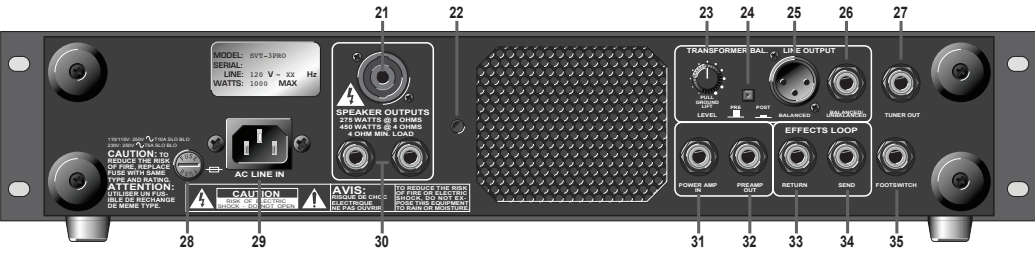

21. SPEAKON® JACK: Use of this heavy-duty connector is recommended when playing at full output levels due to its incredibly high current handling capability. Connect the amplifier to the speaker cabinet(s) using heavy gauge speaker cables terminated with the appropriate connectors. The pin connections for this jack are:

- 1+ = positive
- 1- = negative

22. RACK SUPPORT FASTENER: For the most secure rack installation, it is recommended that a supplemental support be fabricated and fastened to the amplifier via this threaded insert. Use a 1/4-20 threaded bolt that will not protrude more than 1/2" into the amplifier to connect the strap.

23. LINE OUTPUT LEVEL / GROUND LIFT: This control adjusts the output level at both line output jacks. This control works independently from the front panel master control. If necessary, pull this knob to engage the ground lift and eliminate hum.

24. POST-EQ / PRE-EQ: The signal at the line out jacks can be set to either Pre-EQ or Post-EQ with this switch. With the switch in the OUT position, the signal at the jacks is Pre-EQ. This is a direct output not affected by any EQ or boost settings. With the switch in the IN position, the signal is Post-EQ and is controlled and modified by the tone controls, Graphic EQ and the effects loop.

25, 26. TRANSFORMER BALANCED LINE OUTPUTS: These jacks supply a balanced/unbalanced preamp output signal for connecting to a house mixing board, recording console or external amplifiers with balanced inputs. The signal can either be set to Pre- or Post-EQ with the selector switch and its level is controlled by the line out level control.

27. TUNER OUT: This jack supplies the only live output when the mute switch is engaged. This allows for silent tuning through an electronic tuner or killing the house send with a monitor mixer send still active.

28. FUSE: The fuse protects the unit from damage due to overload conditions or AC power line surges. If the fuse blows, replace it only with the same size and type.

(Speakon® is a registered trademark of Neutrik AG.)



The Rear Panel continued

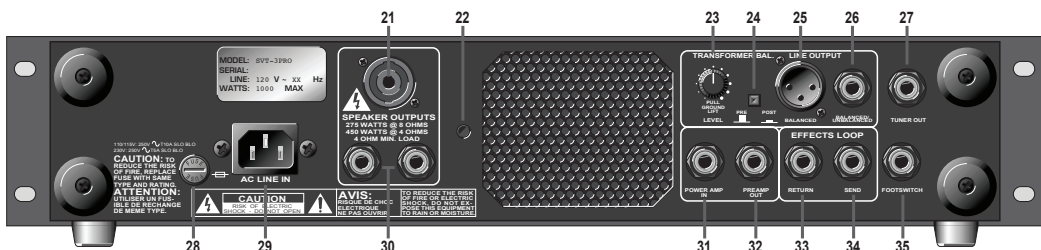

29. IEC POWER INPUT CONNECTOR: This is where you connect the supplied AC power cord.



DO NOT DEFEAT THE GROUND PRONG OF THE AC PLUG!

30. SPEAKER OUTPUTS: These mono 1/4" TS output jacks supply speaker-level power to the speaker cabinet. The rated power output is 275 watts rms into 8 ohms or 450 watts rms into 4 ohms.

The two identical outputs are wired in parallel, and you can use either one, or use both. Make sure the total speaker impedance load is 4 ohms or greater.

For example, you could connect:

Two 16 ohm speakers (an 8 ohm load),

Two 8 ohm speakers (a 4 ohm load)

or one 4 ohm speaker.

Use speaker cables with 1/4" TS ends to make the connections. Do not use instrument cables as they may overheat.

We recommend using the Speakon jack [22] whenever playing at full output levels.

31. POWER AMP IN: This jack connects directly to the internal power amp for use with an external preamp. When using an external source, connect the OUTPUT of the source to this jack using a shielded instrument cable to feed the signal into the power amp section. The internal signal is disconnected when a plug is inserted into this jack.

32. PREAMP OUT: This jack is a direct post master preamp output for use with an external power amp. Connect the external amp's input to this jack using a shielded instrument cable.

33. EFFECTS LOOP RETURN: When using an external signal processor, connect the OUTPUT of the effect to this jack using a shielded instrument cable to feed the processed signal into the unit.

34. EFFECTS LOOP SEND: When using an external signal processor, connect the INPUT of the effect to this jack using a shielded instrument cable to send the post-EQ signal to the effect for processing.

35. FOOTSWITCH: Connect a dual footswitch to this jack for remote Mute and EQ On/Off control. On the stereo 1/4" plug, the tip controls Mute and the ring controls EQ On/Off. The EQ footswitch overrides the front panel switch and the Mute function is available from either location.

NOTE: A footswitch may be purchased at your local Ampeg Dealer or ordered directly from LOUD Technologies Inc. Be sure to ask for model #AFP2.

OTHER: Make sure that the ventilation openings are not obscured in any way. This will allow the flow of cooling air to the power amplifier's heatsinks.



Suggested Settings

A note about the Graphic EQ:

The Graphic EQ may be used in two ways:

- 1) To fine tune the sound, make small adjustments at the desired frequencies and leave the EQ on throughout the entire session. (This is great for adapting to varying room acoustics when playing multiple venues) and...
- 2) For a completely different sound, make larger adjustments and only activate the EQ when a "second channel" sound is required (such as during bass solos).

ROCK:

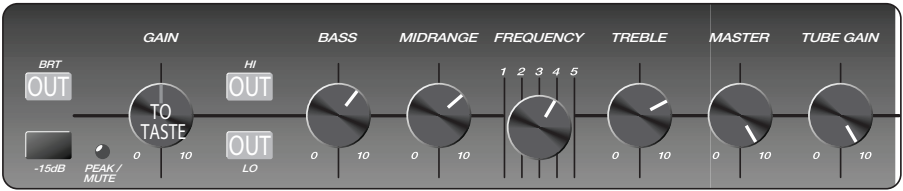

JAZZ:

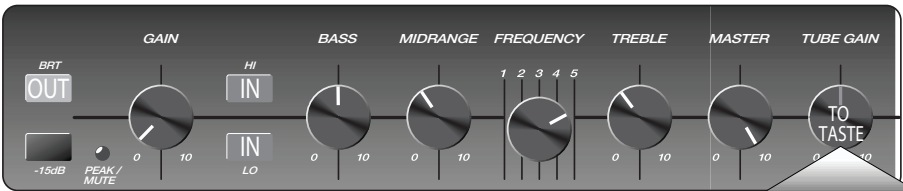

Set at "10" for the cleanest sound.
Set at "5" for moderate softness.
Set at "0" for a very soft feel.

COUNTRY:

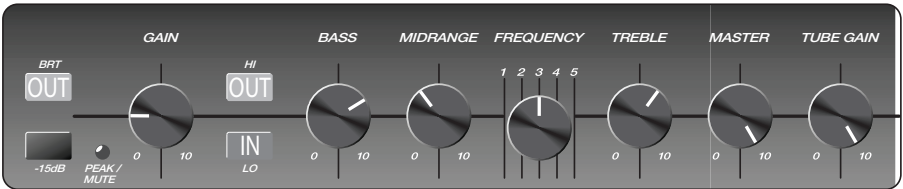

FUNK "POPPING:"

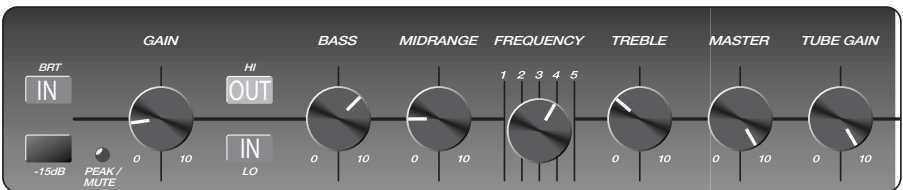



Personal Settings

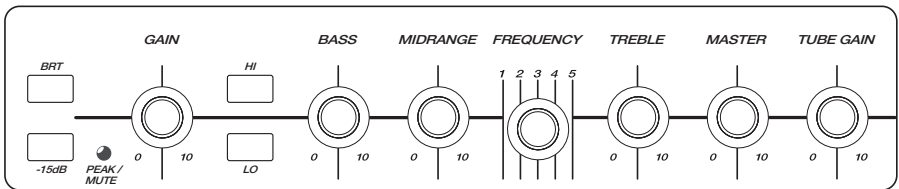
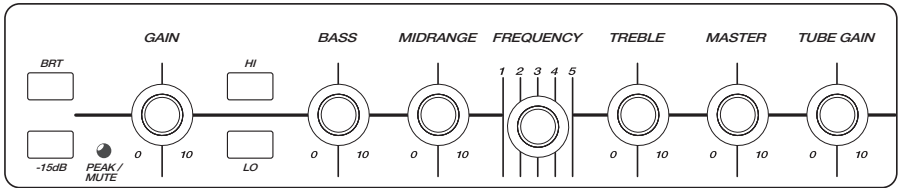
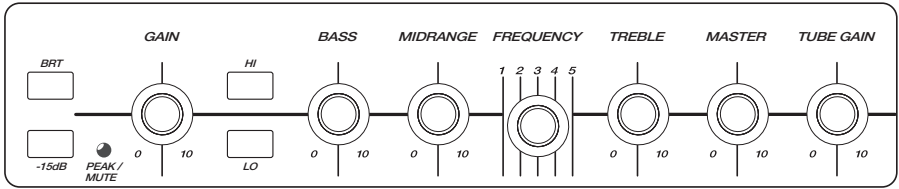
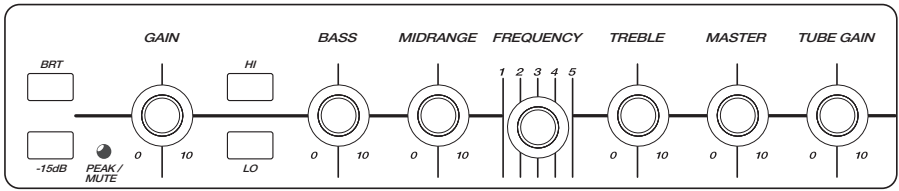
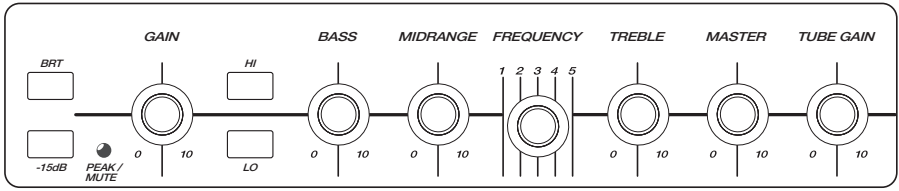



Rack Mounting

When mounting the SVT-3 PRO into a rack, the four bottom feet should be removed to maintain the two rack space height of the amplifier. Be sure to keep the feet and their attachment bolts for future use. If the feet are reinstalled, never use screws which will protrude farther into the amplifier than the original hardware.

The rack must be a high quality enclosure capable of securely supporting the weight of the amplifier. Tighten the mounting screws securely through the amplifier's face plate, into the rack rails. Check the rack and mounting screws occasionally to ensure a continually safe and secure installation.

A 1/4–20 threaded insert is provided on the rear of the amplifier for connection to an additional support bracket. It is highly recommended that this additional support be used when rack mounting the amplifier. It must not protrude more than 1/2" into the amplifier.

Thermal Considerations

The amplifier is fan cooled with a single fan. Air is drawn through the side panel vent to cool down the amplifier heatsinks, and then expelled through the rear panel vents. When installing, be sure to allow sufficient air space around the front, sides and rear of the amplifier for adequate cooling for the heatsinks. Leave at least one rack space above and below, and at least six inches behind and in front of the chassis to allow proper ventilation. The rear of the rack should be unobstructed and placed no closer than 10" from walls or other large obstructions. When the amplifier is first turned on, the fan runs at a low speed. As the power output increases and the amp warms up, the fan gradually increases in speed to provide additional cooling. If the amplifier should overheat, a thermal switch turns off the power amplifier, allowing the heatsink to cool down. Once the amplifier has cooled to a safe operating temperature, the thermal switch resets and reactivates the amplifier. If this should occur, identify the cause of the problem and take corrective action. For example:

- Provide better ventilation
- Install a fan in the rack to move more air
- Make sure the amplifier is not overloaded with too low of a load impedance or by a short circuit on the speaker line



Block Diagram

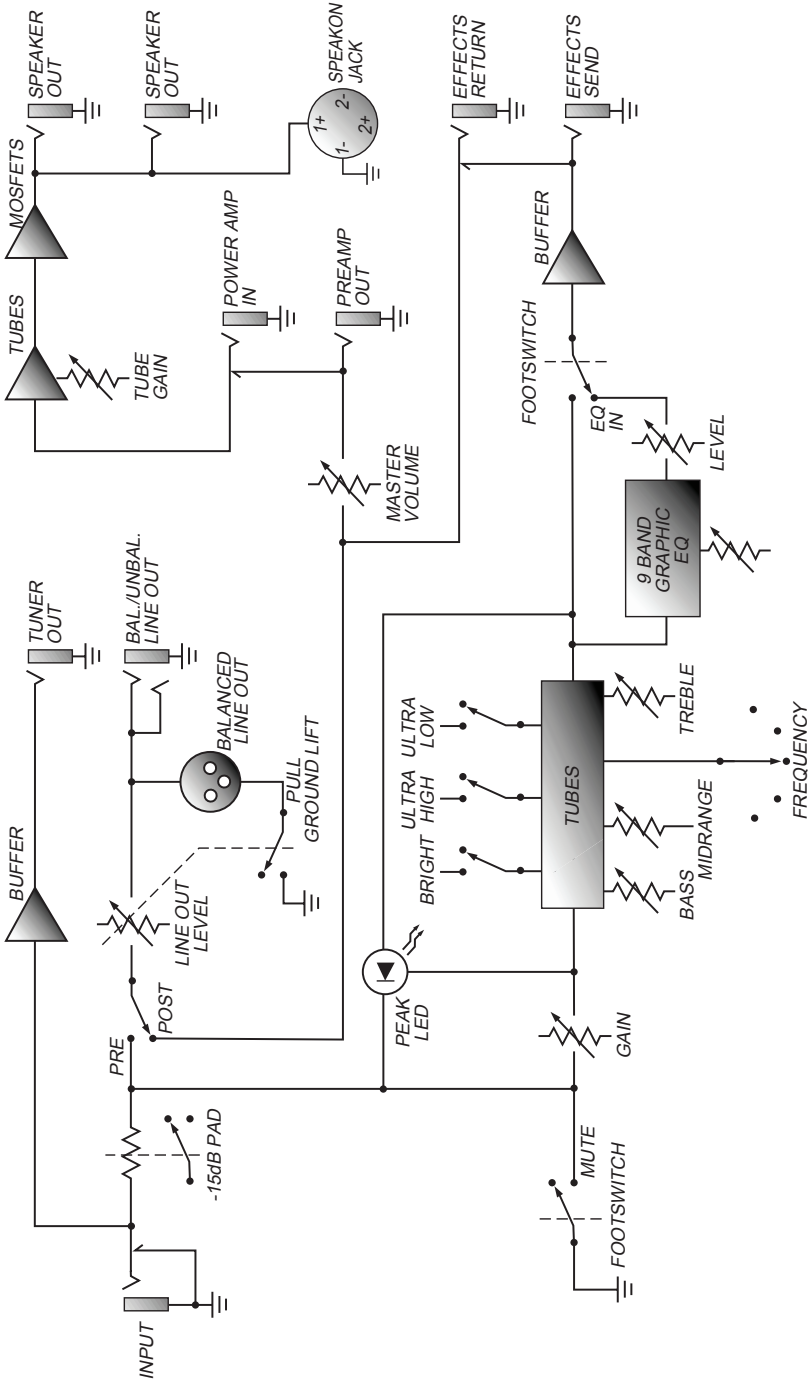



SVT-3 PRO TECHNICAL SPECIFICATIONS

Output Power Rating	450 watts rms @ 4 ohms, 3% THD 275 watts rms @ 8 ohms, 3% THD
Signal to Noise Ratio	80 dB (20 Hz–30 kHz), ref: 1% THD+N into a 4 ohm load with –20 dB stimulus (“normal”)
Maximum Gain	63 dB @ 1 kHz, tone controls centered
Tube Complement	12AX7 (4), 12AU7 (1)
Tone Controls	Bass: +12 / –12 dB @ 50 Hz Midrange: +15 / –15 dB @ 220 Hz, 450 Hz, 800 Hz, 1.6 kHz or 3 kHz Treble: +14 / –19 dB @ 5 kHz
Graphic EQ Level	+10 / –10 dB
Graphic EQ Range	33 Hz: +15 / –15 dB 80 Hz: +8 / –8 dB 150 Hz: +8 / –8 dB 300 Hz: +8 / –8 dB 600 Hz: +8 / –8 dB 900 Hz: +8 / –8 dB 2 kHz: +8 / –8 dB 5 kHz: +9 / –9 dB 8 kHz: +10 / –10 dB
Bright Switch	+6 dB @ 2 kHz
Ultra Hi Switch	+6 dB @ 5 kHz
Ultra Lo Switch	+2.5 dB @ 50 Hz –12 dB @ 560 Hz +1.5 dB @ 5 kHz
Footswitch Jack	Graphic EQ On/Off, Mute On/Off [Tip = Mute, Ring = EQ]
Power Requirements	~100–120 VAC, 50–60 Hz, 390 W [Domestic] ~200–240 VAC, 50–60 Hz, 390 W [Export]
Size (H x W x D)	4.0 in / 102 mm (with feet) x 19.0 in / 483 mm (with ears) / 17.4 in / 442 mm (without ears) x 15.5 in / 394 mm
Weight	26.0 lb / 11.8 kg (approximately)



Troubleshooting

In the unlikely event that your SVT-3 PRO should malfunction, take a few minutes to troubleshoot it before you call for service. You can save yourself time and money by doing it yourself, and often the cure for the problem is something quite simple.

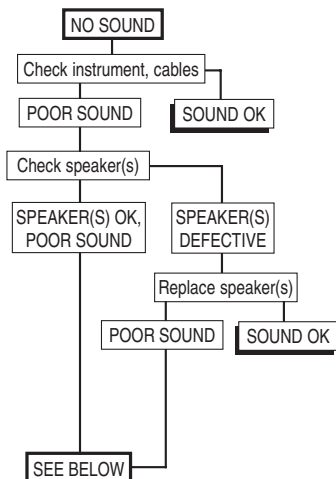
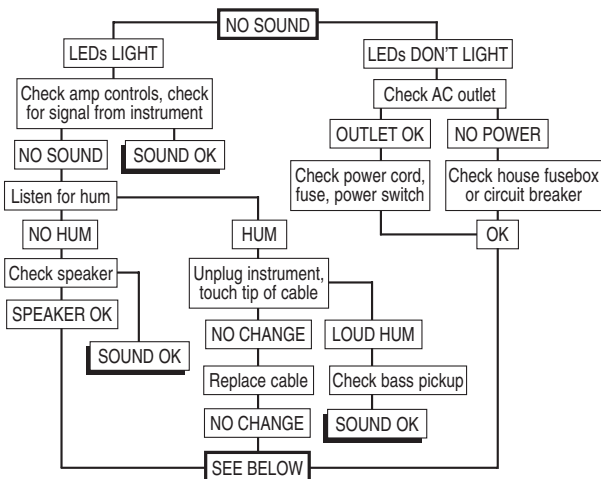

If the problem isn't covered above, or if the steps lead you here, then contact your Ampeg dealer for service information. Also, you should refer the amp for servicing if it gets dropped, has liquid spilled into it, or sustains damage to its power cord.

Service Information

If you are having a problem with your SVT-3 PRO, you can go to our website (www.ameg.com) and click on Support for service information, or call Technical Support at 1-800-898-3211 Monday-Friday during normal business hours, Pacific Time, to receive assistance. If you are outside of the U.S., contact your local distributor for technical support and service.

The SVT-3 PRO is covered with sheet metal and aluminum, not unlike robots, spaceships and other cool things. Clean with a dry lint-free cloth. Never spray cleaning agents on the SVT-3 PRO. Avoid abrasive cleansers which would damage the finish.

Ampeg continually develops new products and improves upon existing ones. For this reason, the specifications and information in this manual are subject to change without notice.

"Ampeg" is a registered trademark of LOUD Technologies Inc. All other brand names mentioned are trademarks or registered trademarks of their respective holders and are hereby acknowledged.

Amplifier

2VT-3 PRO

Bass Guitar Amplifier

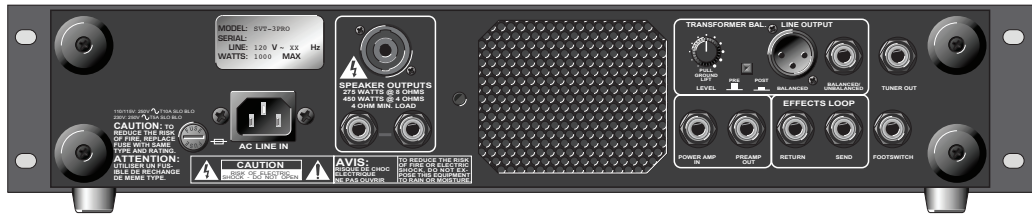

Owner's Manual