



CK88

CK61

STAGE KEYBOARD  
CLAVIER DE SCÈNE  
TECLADO DE ESCENARIO

OWNER'S MANUAL  
MODE D'EMPLOI  
MANUAL DE INSTRUCCIONES

English

Français

Español

EN  
FR  
ES

**COMPLIANCE INFORMATION STATEMENT**  
**(Supplier's declaration of conformity procedure)**

Responsible Party: Yamaha Corporation of America  
Address: 6600 Orangethorpe Ave., Buena Park, Calif. 90620  
Telephone: 714-522-9011  
Type of Equipment: STAGE KEYBOARD  
Model Name: CK88, CK61

This device complies with Part 15 of the FCC Rules.

Operation is subject to the following two conditions:

- 1) this device may not cause harmful interference, and
- 2) this device must accept any interference received including interference that may cause undesired operation.

(529-M02 FCC sdoc YCA 01)

**FCC INFORMATION (U.S.A.)**

**1. IMPORTANT NOTICE: DO NOT MODIFY THIS UNIT!**

This product, when installed as indicated in the instructions contained in this manual, meets FCC requirements. Modifications not expressly approved by Yamaha may void your authority, granted by the FCC, to use the product.

**2. IMPORTANT:** When connecting this product to accessories and/or another product use only high quality shielded cables.

Cable/s supplied with this product **MUST** be used. Follow all installation instructions. Failure to follow instructions could void your FCC authorization to use this product in the USA.

**3. NOTE:** This product has been tested and found to comply with the requirements listed in FCC Regulations, Part 15 for Class "B" digital devices. Compliance with these requirements provides a reasonable level of assurance that your use of this product in a residential environment will not result in harmful interference with other electronic devices. This equipment generates/uses radio frequencies and, if not installed and used according to the instructions found in the users manual, may cause interference harmful to the operation of other electronic devices. Compliance with FCC regulations does not guarantee that interference will not occur in all installations. If this product is found to be the source of interference, which can be determined by turning the unit "OFF" and "ON", please try to eliminate the problem by using one of the following measures:

- Relocate either this product or the device that is being affected by the interference.
- Utilize power outlets that are on different branch (circuit breaker or fuse) circuits or install AC line filter/s.
- In the case of radio or TV interference, relocate/reorient the antenna. If the antenna lead-in is 300 ohm ribbon lead, change the lead-in to co-axial type cable.

If these corrective measures do not produce satisfactory results, please contact the local retailer authorized to distribute this type of product. If you cannot locate the appropriate retailer, please contact Yamaha Corporation of America, 6600 Orangethorpe Ave., Buena Park, CA90620, USA.

The above statements apply **ONLY** to those products distributed by Yamaha Corporation of America or its subsidiaries.

(529-M04 FCC class B YCA 01)

## For AC adaptor

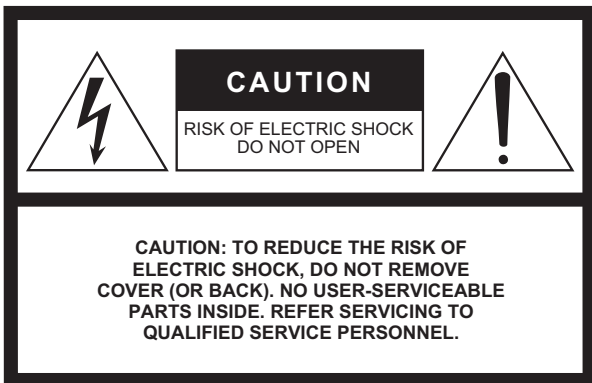

### Explanation of Graphical Symbols

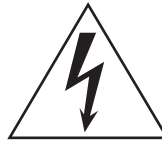

The lightning flash with arrowhead symbol within an equilateral triangle is intended to alert the user to the presence of uninsulated "dangerous voltage" within the product's enclosure that may be of sufficient magnitude to constitute a risk of electric shock to persons.



The exclamation point within an equilateral triangle is intended to alert the user to the presence of important operating and maintenance (servicing) instructions in the literature accompanying the product.

## IMPORTANT SAFETY INSTRUCTIONS

- 1 Read these instructions.
- 2 Keep these instructions.
- 3 Heed all warnings.
- 4 Follow all instructions.
- 5 Do not use this apparatus near water.
- 6 Clean only with dry cloth.
- 7 Do not block any ventilation openings. Install in accordance with the manufacturer's instructions.
- 8 Do not install near any heat sources such as radiators, heat registers, stoves, or other apparatus (including amplifiers) that produce heat.
- 9 Do not defeat the safety purpose of the polarized or grounding-type plug. A polarized plug has two blades with one wider than the other. A grounding type plug has two blades and a third grounding prong. The wide blade or the third prong are provided for your safety. If the provided plug does not fit into your outlet, consult an electrician for replacement of the obsolete outlet.
- 10 Protect the power cord from being walked on or pinched particularly at plugs, convenience receptacles, and the point where they exit from the apparatus.
- 11 Only use attachments/accessories specified by the manufacturer.
- 12 Use only with the cart, stand, tripod, bracket, or table specified by the manufacturer, or sold with the apparatus. When a cart is used, use caution when moving the cart/apparatus combination to avoid injury from tip-over.
- 13 Unplug this apparatus during lightning storms or when unused for long periods of time.
- 14 Refer all servicing to qualified service personnel. Servicing is required when the apparatus has been damaged in any way, such as power-supply cord or plug is damaged, liquid has been spilled or objects have fallen into the apparatus, the apparatus has been exposed to rain or moisture, does not operate normally, or has been dropped.



### WARNING

TO REDUCE THE RISK OF FIRE OR ELECTRIC SHOCK, DO NOT EXPOSE THIS APPARATUS TO RAIN OR MOISTURE.

(502-M01 UL 60065-1 en 01)

The model number, serial number, power requirements, etc., may be found on or near the name plate, which is at the bottom of the unit. You should note this serial number in the space provided below and retain this manual as a permanent record of your purchase to aid identification in the event of theft.

**Model No.**

---

**Serial No.**

---

(1003-M06 plate bottom en 01)

### Information for users on collection and disposal of old equipment and used batteries:



These symbols on the products, packaging, and/or accompanying documents mean that used electrical and electronic products and batteries should not be mixed with general household waste. For proper treatment, recovery and recycling of old products and used batteries, please take them to applicable collection points, in accordance with your national legislation.



By disposing of these products and batteries correctly, you will help to save valuable resources and prevent any potential negative effects on human health and the environment which could otherwise arise from inappropriate waste handling.



For more information about collection and recycling of old products and batteries, please contact your local municipality, your waste disposal service or the point of sale where you purchased the items.

#### For business users in the European Union:

If you wish to discard electrical and electronic equipment, please contact your dealer or supplier for further information.



#### Information on Disposal in other Countries outside the European Union:

These symbols are only valid in the European Union. If you wish to discard these items, please contact your local authorities or dealer and ask for the correct method of disposal.

**Cd**

#### Note for the battery symbol (bottom symbol example):

This symbol might be used in combination with a chemical symbol. In this case it complies with the requirement set by the EU Battery Directive for the chemical involved.

(58-M03 WEEE battery en 01)

### For Singapore

Users are only allowed to use EN 50075 detachable and interchangeable 2-pin plugs or BS 1363-3 or SS 145-3 detachable and interchangeable 3-pin plugs that are approved and suitable to use in Singapore.

(604-M02 SG adaptor 01)

This transmitter must not be co-located or operated in conjunction with any other antenna or transmitter.

(554-M01)

This equipment complies with FCC radiation exposure limits set forth for an uncontrolled environment and meets the FCC radio frequency (RF) Exposure Guidelines. This equipment should be installed and operated keeping the radiator at least 20 cm or more away from person's body.

(555-M03 FCC mobile SAR 01)

This equipment complies with ISED radiation exposure limits set forth for an uncontrolled environment and meets RSS-102 of the ISED radio frequency (RF) Exposure rules. This equipment should be installed and operated keeping the radiator at least 20 cm or more away from person's body.

(555-M04 ISED mobile SAR en 01)

This device contains licence-exempt transmitter(s)/receiver(s) that comply with Innovation, Science and Economic Development Canada's licence-exempt RSS(s). Operation is subject to the following two conditions:

1. This device may not cause interference.
2. This device must accept any interference, including interference that may cause undesired operation of the device.

(555-M13 ISED RSS en 01)

#### **EN SIMPLIFIED EU DECLARATION OF CONFORMITY / SIMPLIFIED UK DECLARATION OF CONFORMITY**

Hereby, Yamaha Music Europe GmbH declares that the radio equipment type [CK88, CK61] is in compliance with Directive 2014/53/EU and the radio equipment regulations of UK. The full texts of the EU declaration of conformity and the UK declaration of conformity are available at the following internet address:

<https://europe.yamaha.com/en/support/compliance/doc.html>

#### **FR DECLARATION UE DE CONFORMITE SIMPLIFIEE**

Le soussigné, Yamaha Music Europe GmbH, déclare que l'équipement radioélectrique du type [CK88, CK61] est conforme à la directive 2014/53/UE. Le texte complet de la déclaration UE de conformité est disponible à l'adresse internet suivante :

<https://europe.yamaha.com/en/support/compliance/doc.html>

#### **DE VEREINFACHTE EU-KONFORMITÄTSEKTLÄRUNG**

Hiermit erklärt Yamaha Music Europe GmbH, dass der Funkanlagentyp [CK88, CK61] der Richtlinie 2014/53/EU entspricht. Der vollständige Text der EU-Konformitätserklärung ist unter der folgenden Internetadresse verfügbar:

<https://europe.yamaha.com/en/support/compliance/doc.html>

#### **SV FÖRENKLAD EU-FÖRSÄKRAN OM ÖVERENSSTÄMMELSE**

Härmed försäkrar Yamaha Music Europe GmbH att denna typ av radioustrüstning [CK88, CK61] överensstämmer med direktiv 2014/53/EU. Den fullständiga texten till EU-försäkran om överensstämmelse finns på följande webbadress:

<https://europe.yamaha.com/en/support/compliance/doc.html>

#### **IT DICHIARAZIONE DI CONFORMITÀ UE SEMPLIFICATA**

Il fabbricante, Yamaha Music Europe GmbH, dichiara che il tipo di apparecchiatura radio [CK88, CK61] è conforme alla direttiva 2014/53/UE. Il testo completo della dichiarazione di conformità UE è disponibile al seguente indirizzo Internet:

<https://europe.yamaha.com/en/support/compliance/doc.html>

#### **ES DECLARACIÓN UE DE CONFORMIDAD SIMPLIFICADA**

Por la presente, Yamaha Music Europe GmbH declara que el tipo de equipo radioeléctrico [CK88, CK61] es conforme con la Directiva 2014/53/UE. El texto completo de la declaración UE de conformidad está disponible en la dirección Internet siguiente:

<https://europe.yamaha.com/en/support/compliance/doc.html>

#### **PT DECLARAÇÃO UE DE CONFORMIDADE SIMPLIFICADA**

O(a) abaixo assinado(a) Yamaha Music Europe GmbH declara que o presente tipo de equipamento de rádio [CK88, CK61] está em conformidade com a Diretiva 2014/53/UE. O texto integral da declaração de conformidade está disponível no seguinte endereço de Internet:

<https://europe.yamaha.com/en/support/compliance/doc.html>

#### **NL VEREENVOUDIGDE EU-CONFORMITEITSVERKLARING**

Hierbij verklaar ik, Yamaha Music Europe GmbH, dat het type radioapparatuur [CK88, CK61] conform is met Richtlijn 2014/53/EU. De volledige tekst van de EU-conformiteitsverklaring kan worden geraadpleegd op het volgende internetadres:

<https://europe.yamaha.com/en/support/compliance/doc.html>

**BG** **ОПРОСТЕНА ЕС ДЕКЛАРАЦИЯ ЗА СЪОТВЕТСТВИЕ**

С настоящото Yamaha Music Europe GmbH декларира, че този тип радиосъоръжение [CK88, CK61] е в съответствие с Директива 2014/53/ЕС. Цялостният текст на ЕС декларацията за съответствие може да се намери на следния интернет адрес:

<https://europe.yamaha.com/en/support/compliance/doc.html>

**CS** **ZJEDNODUŠENÉ EU PROHLÁŠENÍ O SHODĚ**

Tímto Yamaha Music Europe GmbH prohlašuje, že typ rádiového zařízení [CK88, CK61] je v souladu se směrnicí 2014/53/EU. Úplné znění EU prohlášení o shodě je k dispozici na této internetové adrese:

<https://europe.yamaha.com/en/support/compliance/doc.html>

**DA** **FORENKLET EU-OVERENSSTEMMELSESESKLÆRING**

Hermed erklærer Yamaha Music Europe GmbH, at radioudstyrstypen [CK88, CK61] er i overensstemmelse med direktiv 2014/53/EU. EU-overensstemmelseserklæringens fulde tekst kan findes på følgende internetadresse:

<https://europe.yamaha.com/en/support/compliance/doc.html>

**ET** **LIHTSUSTATUD ELI VASTAVUSDEKLARATSIOON**

Käesolevaga deklareerib Yamaha Music Europe GmbH, et käesolev raadioseadme tüüp [CK88, CK61] vastab direktiivi 2014/53/EL nõuetele. ELi vastavusdeklaratsiooni täielik tekst on kättesaadav järgmisel internetiaadressil:

<https://europe.yamaha.com/en/support/compliance/doc.html>

**EL** **ΑΠΛΟΥΣΤΕΥΜΕΝΗ ΔΗΛΩΣΗ ΣΥΜΜΟΡΦΩΣΗΣ ΕΕ**

Με την παρούσα ο/η Yamaha Music Europe GmbH, δηλώνει ότι ο ραδιοεξοπλισμός [CK88, CK61] πληροί την οδηγία 2014/53/ΕΕ. Το πλήρες κείμενο της δήλωσης συμμόρφωσης ΕΕ διατίθεται στην ακόλουθη ιστοσελίδα στο διαδίκτυο:

<https://europe.yamaha.com/en/support/compliance/doc.html>

**HR** **POJEDNOSTAVLJENA EU IZJAVA O SUKLADNOSTI**

Yamaha Music Europe GmbH ovime izjavljuje da je radijska oprema tipa [CK88, CK61] u skladu s Direktivom 2014/53/EU. Cjeloviti tekst EU izjave o sukladnosti dostupan je na sljedećoj internetskoj adresi:

<https://europe.yamaha.com/en/support/compliance/doc.html>

**LV** **VIENKĀRŠOTA ES ATBILSTĪBAS DEKLARĀCIJA**

Ar šo Yamaha Music Europe GmbH deklarē, ka radioiekārta [CK88, CK61] atbilst Direktīvai 2014/53/ES. Pilns ES atbilstības deklarācijas teksts ir pieejams šādā interneta vietnē:

<https://europe.yamaha.com/en/support/compliance/doc.html>

**LT** **SUPAPRASTINTA ES ATITIKTIES DEKLARACIJA**

Aš, Yamaha Music Europe GmbH, patvirtinu, kad radijo įrenginių tipas [CK88, CK61] atitinka Direktyvą 2014/53/ES. Visas ES atitikties deklaracijos tekstas prieinamas šiuo interneto adresu:

<https://europe.yamaha.com/en/support/compliance/doc.html>

**HU** **EGYSZERŰSÍTETT EU-MEGFELELŐSÉGI NYILATKOZAT**

Yamaha Music Europe GmbH igazolja, hogy a [CK88, CK61] típusú rádióberendezés megfelel a 2014/53/EU irányelvnek. Az EU-megfelelőségi nyilatkozat teljes szövege elérhető a következő internetes címen:

<https://europe.yamaha.com/en/support/compliance/doc.html>

**PL** **UPROSZCZONA DEKLARACJA ZGODNOŚCI UE**

Yamaha Music Europe GmbH niniejszym oświadcza, że typ urządzenia radiowego [CK88, CK61] jest zgodny z dyrektywą 2014/53/UE. Pełny tekst deklaracji zgodności UE jest dostępny pod następującym adresem internetowym:

<https://europe.yamaha.com/en/support/compliance/doc.html>

**RO** **DECLARAȚIA UE DE CONFORMITATE SIMPLIFICATĂ**

Prin prezenta, Yamaha Music Europe GmbH declară că tipul de echipamente radio [CK88, CK61] este în conformitate cu Directiva 2014/53/UE. Textul integral al declarației UE de conformitate este disponibil la următoarea adresă internet:

<https://europe.yamaha.com/en/support/compliance/doc.html>

**SK** **ZJEDNODUŠENÉ EÚ VYHLÁSENIE O ZHODE**

Yamaha Music Europe GmbH týmto vyhlasuje, že rádiové zariadenie typu [CK88, CK61] je v súlade so smernicou 2014/53/EÚ. Úplné EÚ vyhlásenie o zhode je k dispozícii na tejto internetovej adrese:

<https://europe.yamaha.com/en/support/compliance/doc.html>

**SL POENOSTAVLJENA IZJAVA EU O SKLADNOSTI**

Yamaha Music Europe GmbH potrjuje, da je tip radijske opreme [CK88, CK61] skladen z Direktivo 2014/53/EU. Celotno besedilo izjave EU o skladnosti je na voljo na naslednjem spletnem naslovu:

<https://europe.yamaha.com/en/support/compliance/doc.html>

**FI YKSINKERTAISTETTU EU-VAATIMUSTENMUKAISUUSVAKUUTUS**

Yamaha Music Europe GmbH vakuuttaa, että radiolaitetyyppi [CK88, CK61] on direktiivin 2014/53/EU mukainen. EU-vaatimustenmukaisuusvakuutuksen täysimittainen teksti on saatavilla seuraavassa internetosoitteessa:

<https://europe.yamaha.com/en/support/compliance/doc.html>

**TR BASİTLEŞTİRİLMİŞ AVRUPA BİRLİĞİ UYGUNLUK BİLDİRİMİ**

İşbu belge ile, Yamaha Music Europe GmbH, radyo cihaz tipinin [CK88, CK61], Direktif 2014/53/ AB'ye uygunluğunu beyan eder. AB uyumu beyanının tam metni aşağıdaki internet adresinden edinilebilir:

<https://europe.yamaha.com/en/support/compliance/doc.html>

(559-M01 RED DoC URL 02)

# PRECAUTIONS

## PLEASE READ CAREFULLY BEFORE PROCEEDING

Please keep this manual in a safe and handy place for future reference.

### **WARNING**

**Always follow the basic precautions listed below to avoid the possibility of serious injury or even death from electrical shock, short-circuiting, damages, fire or other hazards. These precautions include, but are not limited to, the following:**

#### **Power supply**

- Do not place the power cord near heat sources such as heaters or radiators. Also, do not excessively bend or otherwise damage the cord, or place heavy objects on it.
- Do not touch the product or the power plug during an electrical storm.
- Use only the correct voltage specified for the product. The required voltage is printed on the name plate of the product.
- Use the specified adaptor (page 69).
- Check the power plug periodically and remove any dirt or dust which may have accumulated on it.
- Insert the power plug firmly all the way into the AC outlet. Using the product when it is not plugged in sufficiently can cause dust to accumulate on the plug, possibly resulting in fire or skin burns.
- When setting up the product, make sure that the AC outlet you are using is easily accessible. If some trouble or malfunction occurs, immediately turn off the power switch and disconnect the plug from the outlet. Even when the power switch is turned off, as long as the power cord is not unplugged from the wall AC outlet, the product will not be disconnected from the power source.
- Do not connect the product to an electrical outlet using a multi-plug outlet extender. Doing so can result in lower sound quality, or possibly cause overheating in the outlet.
- When disconnecting the power plug, always hold the plug itself and not the cord. Pulling by the cord can damage it and cause electric shocks or a fire.
- If not using the product for long periods of time, be sure to pull the power plug from the AC outlet.

#### **Do not disassemble**

- Do not attempt to disassemble the internal parts or modify them in any way.

#### **Water warning**

- Do not expose the product to rain, use it near water or in damp or wet conditions, or place on it any containers (such as vases, bottles or glasses) containing liquids which might spill into any openings or places where water may drop. A liquid such as water getting into the product may cause a fire, electric shocks, or malfunctions.

- Use the AC adaptor indoors only. Do not use in any wet environments.
- Never insert or remove a power plug with wet hands.

#### **Fire warning**

- Do not place any burning items or open flames near the product, since they may cause a fire.

#### **Wireless unit**

- Radio waves from this product may affect electro-medical devices, such as a heart pacemaker implant or defibrillator implant.
  - Do not use the product near medical devices or inside medical facilities. Radio waves from this product may affect electro-medical devices.
  - Do not use the product within 15 cm (6 in.) of persons with a heart pacemaker implant or a defibrillator implant.

#### **Handling**

- Magnetism from this product may affect electro-medical devices, such as a heart pacemaker implant or defibrillator implant.
  - Keep the product away from a heart pacemaker implant or a defibrillator implant.

#### **Batteries**

- Do not dispose of a battery in a fire.
- Do not expose the battery to conditions of extreme low air pressure, cold or heat (such as in direct sunlight or a fire) or excessive dust or humidity. Doing so may result in the battery bursting, causing a fire or injury.
- Follow the precautions below. Failure to do so might result in battery fluid leakage. If the contents of the battery gets on your hands or in your eyes, it can cause blindness, chemical burns, and damage of the product.
  - Use the specified battery type (page 69) only.
  - Do not use new batteries together with old ones.
  - Do not mix battery types.
  - Always make sure all batteries are inserted in conformity with the +/- polarity markings.
  - Do not disassemble a battery.



- When the batteries run out, or if the product is not to be used for a long time, remove the batteries from the product.
- Do not attempt to recharge batteries that are not designed to be charged.
- If the batteries do leak, avoid contact with the leaked fluid. If the battery fluid should come in contact with your eyes, mouth, or skin, wash immediately with water and consult a doctor. Battery fluid is corrosive and may possibly cause loss of sight or chemical burns.
- When using rechargeable batteries, follow the instructions that came with the batteries. Use only the specified charger device and within the specified charging temperature range when charging. Charging with an unspecified charger or at a temperature outside the range may cause leakage, overheating, explosion, or malfunction.
- Keep batteries away from children. A child could accidentally swallow a battery. Failure to observe this may also cause inflammation due to battery fluid leaks.
- Do not put batteries in a pocket or bag, or carry or store them together with pieces of metal. Batteries kept in such condition could short, burst, or leak, causing a fire or injury.

## If you notice any abnormality

- If any of the following problems occur, immediately turn off the power switch and disconnect the power plug from the outlet. If you are using batteries, remove all batteries from the product. Finally have the device inspected by Yamaha service personnel.
  - The power cord or plug becomes frayed or damaged.
  - Unusual smells or smoke are emitted.
  - Some object, or water has been dropped into the product.
  - There is a sudden loss of sound during use of the product.
  - Cracks or other visible damage appear on the product.

## CAUTION

**Always follow the basic precautions listed below to avoid the possibility of physical injury to you or others, or damage to the product or other property. These precautions include, but are not limited to, the following:**

### Location

- Do not place the product in an unstable position or a location with excessive vibration, where it might accidentally fall over and cause injury.

### Connections

- Before connecting the product to other electronic components, turn off the power for all components. Before turning the power on or off for all components, set all volume levels to minimum.
- Be sure to set the volumes of all components at their minimum levels and gradually raise the volume controls while playing the product to set the desired listening level.

### Handling

- Do not insert foreign materials such as metal or paper into any openings or gaps of the product. Failure to observe this may cause a fire, electric shocks, or malfunctions.
- Do not rest your weight on, or place heavy objects on the product, and do not use excessive force on the buttons, switches or connectors.
- Do not use the product or headphones for a long period of time at a high or uncomfortable volume level, since this can cause permanent hearing loss. If you experience any hearing loss or ringing in the ears, consult a physician.
- Remove the power plug from the AC outlet before cleaning the unit. Failure to observe this may cause electric shocks.

Yamaha cannot be held responsible for damage caused by improper use or modifications to the product, or data that is lost or destroyed.

Always turn the power off when the product is not in use.

Even when the [⏻] (Standby/On) switch is in standby status (display is off), electricity is still flowing to the product at the minimum level.

When you are not using the product for a long time, make sure you unplug the power cord from the wall AC outlet.

Make sure to discard used batteries according to local regulations.

## NOTICE

To avoid the possibility of malfunction/ damage to the product, damage to data, or damage to other property, follow the notices below.

### ■ Handling

- Do not use the instrument in the vicinity of a TV, radio, stereo equipment, mobile phone, or other electric devices. Otherwise, the instrument, TV, or radio may generate noise.
- When you use the instrument along with an app on your smart devices, such as a smartphone or tablet, we recommend that you enable "Airplane Mode" on the device to avoid noise caused by communication. When turning on airplane mode, **Bluetooth**® settings may be turned off. Make sure that the setting is turned on before use.
- Depending on the condition of surrounding radio waves, the instrument may possibly malfunction.
- Do not expose the instrument to excessive dust or vibrations, or extreme cold or heat (such as in direct sunlight, near a heater, or in a car during the day) to prevent the possibility of disfiguration, damage to the internal components, or unstable operation.
- Do not place vinyl, plastic, or rubber objects on the instrument, since this might discolor the instrument.

### ■ Maintenance

- When cleaning the instrument, use a soft and dry/slightly damp cloth. Do not use paint thinners, solvents, alcohol, cleaning fluids, or chemical-impregnated wiping cloths.

### ■ Saving settings

- Edited settings are lost when you turn off the power to the instrument. This also occurs when the power is turned off by the Auto Power Off function (page 22). Save the settings to the instrument, or a USB flash drive (page 27). However, the settings saved to the instrument may be lost due to some failure, an operation mistake, etc. Save your important settings onto a USB flash drive (page 27). Before using a USB flash drive, make sure to refer to page 23.
- To protect against settings loss through USB flash drive damage, we recommend that you save your important settings onto a spare USB flash drive as a backup file.

## Information

### ■ About copyrights

The copyright of the "content"\*1 installed in this product belongs to Yamaha Corporation or its copyright holder. Except as permitted by copyright laws and other relevant laws, such as copying for personal use, it is prohibited to "reproduce or divert"\*2 without the permission of the copyright holder. When using the content, consult with a copyright expert.

If you create music or perform with the contents through the original use of the product, and then record and distribute them, the permission of Yamaha Corporation is not required regardless of whether the distribution method is paid or free of charge.

\*1: The word "content" includes a computer program, audio data, Accompaniment Style data, MIDI data, waveform data, voice recording data, music score, and score data, etc.

\*2: The phrase "reproduce or divert" includes taking out the content itself in this product, or recording and distributing it without changes in a similar manner.

### ■ About this manual

- The illustrations and LCD screens as shown in this manual are for instructional purposes only.
- Unless indicated otherwise, the illustrations and displays as shown in this manual are based on the CK61 (in English).
- iPhone and iPad are trademarks of Apple Inc., registered in the U.S. and other countries.
- The **Bluetooth**® word mark and logos are registered trademarks owned by Bluetooth SIG, Inc. and any use of such marks by Yamaha Corporation is under license.



- The company names and product names in this manual are the trademarks or registered trademarks of their respective companies.

### ■ About disposal

When disposing of this product, please contact the appropriate local authorities.

### ■ Firmware

To implement new functions and improve operability, this keyboard may be shipped with an updated version of the firmware installed. A set of manuals for the updated version of the firmware can be downloaded from the website below.

Yamaha Downloads: <https://download.yamaha.com/>

The firmware version of your keyboard can be checked from [MENU] → *Version Info*.

# MEMO



## Welcome

Thank you for purchasing this Yamaha CK88 or CK61 Stage Keyboard!

As the name implies, it is an instrument designed especially for live performance.

With its high-quality sounds and comprehensive features, the CK is ideal in an exceptionally wide range of situations—from live venues, both indoors and outdoors, to studio rehearsal and recording, as well as practice and enjoyment at home.

We recommend that you read this manual carefully so that you can fully take advantage of the advanced and convenient functions of the CK. We also recommend that you keep this manual in a safe and handy place for future reference.

## Accessories

- Owner's Manual (this book) × 1
- AC adaptor (PA-150B) × 1

# Contents

PRECAUTIONS .....	2	Advanced settings .....	28
NOTICE .....	4	Live Set (SETTINGS button) .....	28
Information .....	4	Entire instrument (MENU button) .....	36
<b>Welcome</b> .....	<b>6</b>	Shortcut operations .....	42
<b>Accessories</b> .....	<b>6</b>	Effect list .....	43
<b>About the CK88 and CK61</b> .....	<b>8</b>	<b>Using with External Devices</b> .....	<b>46</b>
Main features .....	8	Precautions when using the USB [TO HOST] terminal .....	46
Basic structure .....	8	Using Smart Devices .....	46
Sound management system .....	9	Connecting to a computer .....	47
<b>Panel controls</b> .....	<b>10</b>	Controlling a synthesizer or tone generator module from the CK .....	47
Front panel .....	10	Controlling the CK from an external keyboard .....	48
Rear panel .....	18	Setting the MIDI transmit and receive channels .....	48
<b>Setting up</b> .....	<b>20</b>	Disabling the internal tone generator sound when the built-in keyboard is played .....	48
Using an AC adaptor .....	20	Setting how the MIDI terminals are used (MIDI Port settings) .....	48
Using batteries .....	21	<b>Data List</b> .....	<b>49</b>
Turning the power on .....	22	Live Set Sound List .....	49
Turning the power off .....	22	Voice List .....	52
Setting the Auto Power Off function .....	22	Control Change Number .....	54
Connecting headphones .....	22	MIDI Data Format .....	56
Using a USB flash drive .....	23	MIDI Data Table .....	58
<b>Basic operations</b> .....	<b>24</b>	MIDI Implementation Chart .....	64
Top screen configuration .....	24	<b>Other information</b> .....	<b>66</b>
Creating a Live Set Sound .....	24	Troubleshooting .....	66
Saving the Live Set Sound .....	24	Display messages .....	68
<b>Other Live Set Sound features</b> .....	<b>25</b>	Specifications .....	69
Applying effects to audio signals from the A/D INPUT jacks .....	25	Index .....	70
Playing back an audio file .....	25		
<b>Managing Live Set Sounds</b> .....	<b>26</b>		
Editing Live Set Sound names .....	26		
Swapping or copying Live Set Sounds .....	26		
Initializing a Live Set Sound .....	26		
Saving the Live Set Sound to a USB flash drive .....	27		
Changing a previously saved file name .....	27		
Loading a Live Set Sound from a USB flash drive .....	27		

# About the CK88 and CK61

## Main features

The CK88 and CK61 are stage keyboards that are ideal for a wide variety of applications and locations.

### ■ Uncompromising performance capabilities—on stage, in the studio, even outdoors

- Loaded with authentic keyboard sounds such as pianos, electric pianos, and organs, as well as many other sounds crucial for contemporary keyboard performance.
- Allows various combinations of three independent parts using layer and split functions, and features connectivity to an external keyboard, computer, or smartphone.
- With its built-in stereo speakers and battery operation capability, you can use the CK virtually anywhere you want.

### ■ Intuitive controls for instant sound crafting

- Features independent control sections for the filter, EG, and effects blocks. These are essential for dynamic sound-making, letting you tweak the sounds in real time as you perform.
- Built-in drawbars exclusively for real-time Organ Voice control—just as on an actual vintage organ.
- Single-button operation for enabling Portamento or unison sounds.

### ■ Extensive support functions for creative performance

- Convenient A/D INPUT jacks let you connect a microphone, and use exclusive built-in effects for the input. This is useful for singing and playing the keyboard in rehearsal or in small-group performances.
- Audio playback function via Bluetooth Audio connection enables performance along with playback of your favorite tunes or using background music from a Bluetooth-equipped device.
- Since the CK88 and CK61 are USB-compatible, connection with a computer or a smartphone is extremely quick and easy—a significant timesaver when setting up for video recording and online live streaming.

## Basic structure

The front panel of this keyboard is divided into three areas. Combining the settings in each of these areas gives you enormous flexibility in creating sounds.

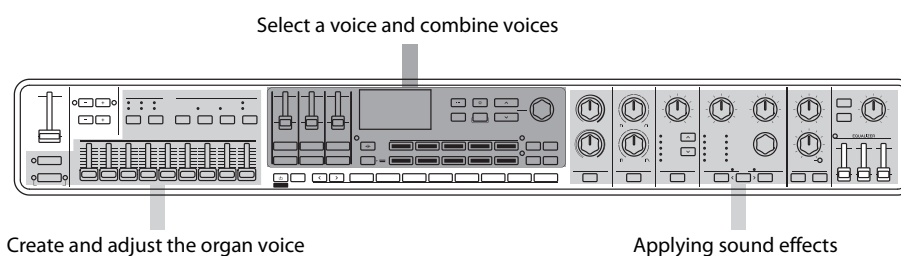

Select a Voice for each of the three keyboard Parts A to C, as well as the On/Off settings and volume balance of each Part, the keyboard split, and effect settings, and then save these settings. You can call up these settings freely as you play and perform.

## Sound management system

The sound you create by combining these settings is managed through the Live Set function.

Within each Live Set you can save a group of settings. One group of settings saved in the Live Set is called a “Live Set Sound.”



Live Set Sounds can be switched instantly by using eight Live Set buttons on the front panel, even during a performance.

Also, eight Live Set Sounds can be registered on a Live Set Page, and you can call up other Live Set Pages by pressing the PAGE buttons.

There are 20 Live Set Pages, allowing you to use a total of 160 voices through this function.

As a factory default, Live Set Pages 1 to 10 contain preset Live Set Sounds.

### Live Set

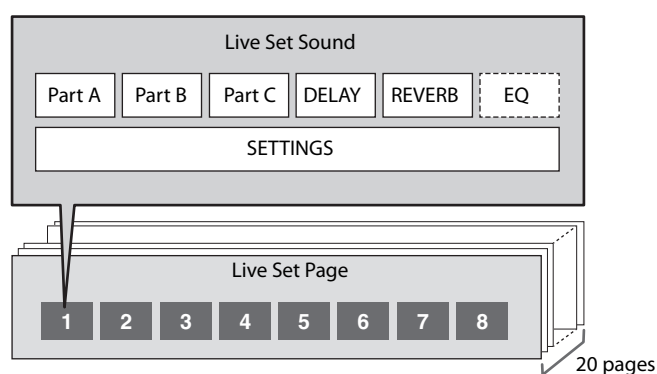

Live Set Sounds can be saved to the internal memory of the keyboard or the USB flash drive, or through Soundmondo for backup and sharing.

- Internal memory
- USB flash drive
- Soundmondo (sound management and sharing service)  
<https://www.yamaha.com/2/soundmondo>

# Panel controls

## Front panel

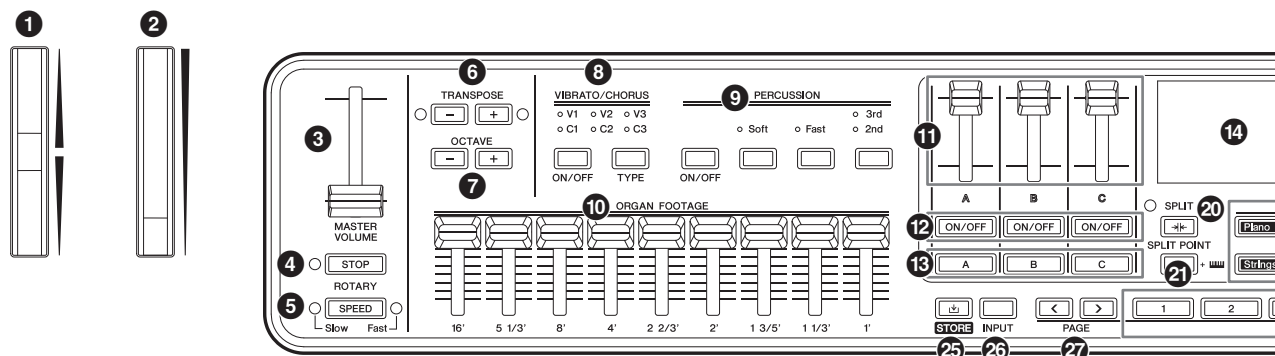

### 1 Pitch Bend Wheel

For use as the Pitch Bend controller. The Pitch Bend range can be set from the [SETTINGS] button → *Controllers* → *Pitch Bend Range* for each Part (page 31).

### 2 Modulation Wheel

For applying modulation to the sound. The modulation can be applied to pitch, amplitude, or filter. You can change the Control Change number assigned to the wheel. Change the setting from the [SETTINGS] button → *Controllers* → *Mod Wheel Assign* (page 31).

#### NOTE

- Change the modulation depth and speed from the [SETTINGS] button → *Sound* → (Part) → *Modulation* (page 29).
- Modulation can be assigned to a different controller.

### 3 [MASTER VOLUME] slider

For adjusting the overall volume of the CK.

### 4 ROTARY [STOP] button

For stopping the rotation effect of the rotary speaker.

### 5 ROTARY [SPEED] button

For changing the rotation speed of the rotary speaker. When the DRIVE is off, or the Drive Type other than *Rotary A* and *Rotary B* is selected, pressing the ROTARY [SPEED] button will activate the function and select *Rotary A*.

### 6 TRANSPOSE buttons

For adjusting the pitch of the entire keyboard in semitones. The value is transmitted as a MIDI message, but not saved for the Live Set Sound. Simultaneously press the [-] and [+] buttons to restore the value to "0."

#### NOTE

Simultaneously press one of the TRANSPOSE buttons and the [ENTER] button to set the *Sound Transpose* for the Live Set Sound (page 42). The *Sound Transpose* setting is stored in a Live Set Sound.

### 7 OCTAVE buttons

For changing the range of the keyboard in octaves. The value is transmitted as a MIDI message, but not saved for the Live Set Sound. Simultaneously press the [-] and [+] buttons to restore the value to "0." The octave setting can be set independently for each part by using the *Note Shift* function. Pressing the OCTAVE button while holding down the PART button will make the OCTAVE button light in the corresponding part color (page 42). The octave setting for the part (*Note Shift* setting) can be stored in a Live Set Sound.



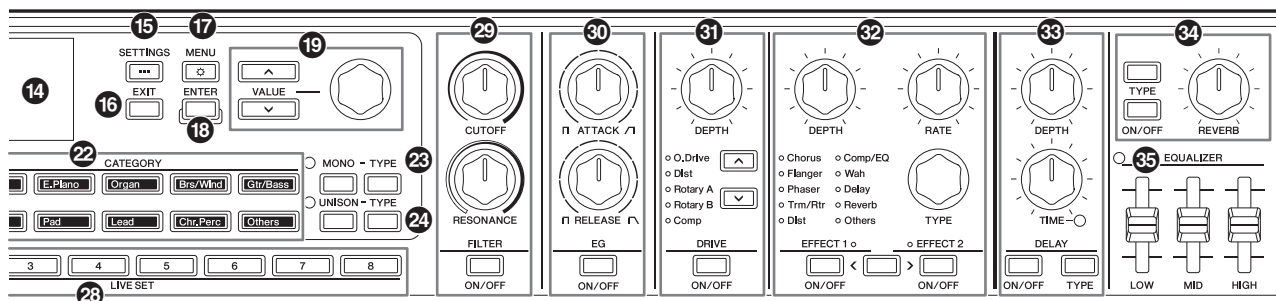

## 8 VIBRATO/CHORUS [ON/OFF] button VIBRATO/CHORUS [TYPE] button

For setting the Vibrato/Chorus effects for the Organ voice.

These buttons can be used when the Organ Voices using the Organ Flutes tone generator (H, V, F, A, and Y) are selected (page 13).

Use the [ON/OFF] button to turn the Vibrato/Chorus effects on or off, and the [TYPE] button to select a vibrato or chorus type.

Pressing the button alternates sequentially between V (vibrato) 1 to 3 and C (chorus) 1 to 3.

### NOTE

Simultaneously press the [ENTER] and VIBRATO/CHORUS [TYPE] buttons to show the list of VIBRATO/CHORUS types in reverse order. This is convenient for selecting a previous type on the list (page 42).

## 9 PERCUSSION [ON/OFF] button PERCUSSION [Soft] button PERCUSSION [Fast] button PERCUSSION [2nd 3rd] button

For setting up the percussion sounds for Organ voice. These buttons can be used when the Organ Voices using the Organ Flutes tone generator (H, V, F, A, and Y) are selected.

Use the [ON/OFF] button to turn the percussion sounds on or off, the [Soft] button to lower the volume, and the [Fast] button to set the faster decay speed for the Percussion sounds.

Use the [2nd 3rd] button to change the pitch of the percussion sounds.

## 10 ORGAN FOOTAGE sliders

For setting the component elements of the Organ Voice.

These sliders can be used only when the Organ Voices using the Organ Flutes tone generator (H, V, F, A, and Y) are selected.

Just as with the drawbars on a vintage organ, moving the sliders downwards (toward you) increases the volume of the component elements to make the overall organ tone louder. To create the organ tone you desire, you can move each of these sliders to change the component elements of the sound.

### NOTE

- No organ sound will be produced if all the ORGAN FOOTAGE sliders are moved up.
- In many cases when calling up a setting from LIVE SET [1]–[8], the actual position of the sliders and the value of the setting do not match. Once you move a slider, its position is reflected in the settings. For changing the settings so that the values for the positions of all the sliders are immediately reflected in the settings without having to move the sliders, change the setting from the [MENU] button → *General* → *Control Panel* → *Controller Mode* (page 39).

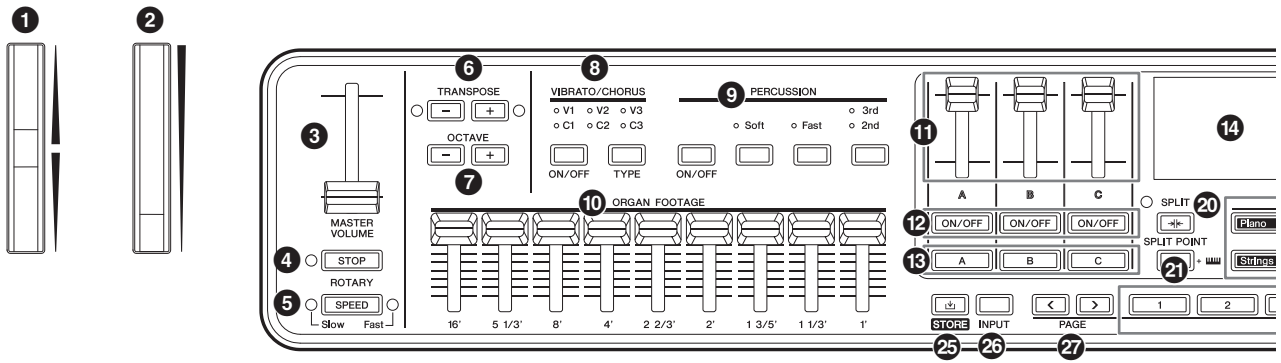

The component tones produced by moving each of the sliders are shown below.

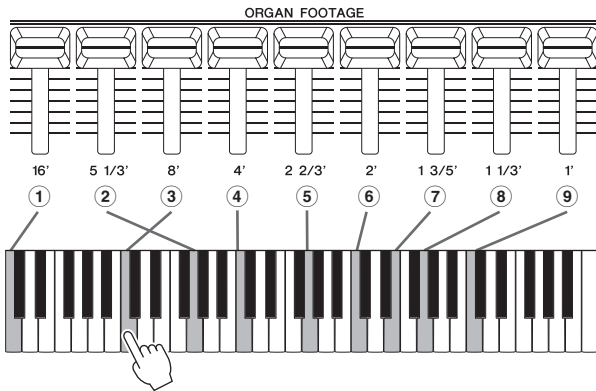

Sliders	Tone
① 16'	8 scale degrees below
② 5 1/3'	5 scale degrees above
③ 8'	Fundamental tone
④ 4'	8 scale degrees above
⑤ 2 2/3'	12 scale degrees above
⑥ 2'	15 scale degrees above
⑦ 1 3/5'	17 scale degrees above
⑧ 1 1/3'	19 scale degrees above
⑨ 1'	22 scale degrees above

### 11 Part Volume Sliders

For setting the volume for each Part.

### 12 Part [ON/OFF] buttons

For switching each Part on or off.

### 13 Part [A]–[C] select buttons

For selecting the desired Part for changing the settings.

When the Part is enabled here, you can control the following settings from the front panel.

- Voice category selection

- Organ voice settings
- MONO and UNISON settings
- Filter
- EG
- Drive
- Effect1 and Effect2

By pressing multiple Part select buttons, you can set the same filter and effects for those selected Parts at once.

#### NOTE

By simultaneously holding down two of the Part select buttons, you can swap the settings for those Parts (page 42). This is convenient when you wish to switch the right- and left-hand Parts for the Split setting.

### 14 Display (LCD)

For displaying the system messages, parameter settings, and other information depending on the function currently being used.

### 15 [SETTINGS] button

For calling up the screens for making detailed settings for the currently selected Live Set Sound (page 28).

You can make various settings, including the Part sound and controller customizations, Audio Trigger function, and the effects for A/D Input.

After editing the settings, press the [STORE] button to store the settings.

Settings made here are stored in the Live Set Sound.

#### NOTE

Simultaneously press the [ENTER] and [SETTINGS] buttons to instantly initialize the Live Set Sound (page 42).

### 16 [EXIT] button

While using the MENU and SETTINGS screens, press this button to exit from the current screen and return to the previous level.

Holding down the [EXIT] button returns to the Top screen.

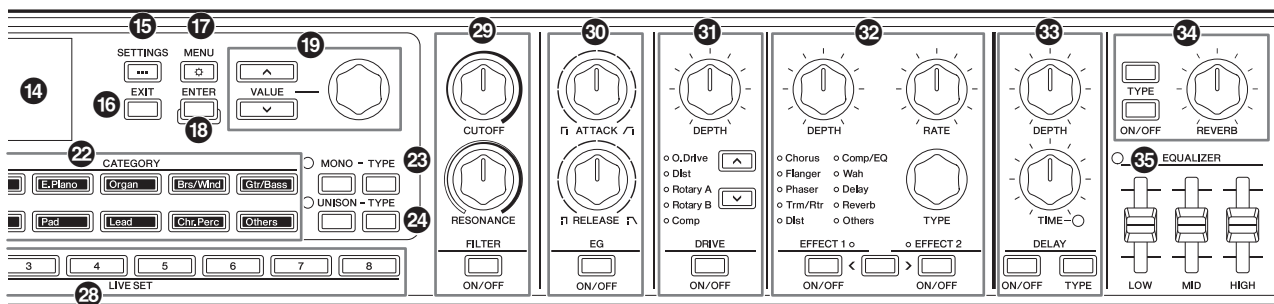

### 17 [MENU] button

For calling up the screens for making overall settings (page 36).  
 Simultaneously press the [ENTER] and [MENU] buttons to switch the panel lock on or off (page 42).

### 18 [ENTER] button

For confirming the parameter value or each operation. By holding down the [ENTER] button and operating other buttons or knobs, you can use shortcut operations (page 42).

### 19 VALUE buttons Encoder dial

For changing the currently selected parameter value. In the MENU and SETTINGS screens, use the encoder dial to move the cursor (or highlight) up and down.

### 20 [SPLIT] button

For selecting the Split settings. Pressing the button turns on the Split function, and each time you press the button, the settings change alternately in the order listed below.

The lamp is on while the Split setting is selected, and the lamp is off while the Split setting is deselected, and the Layer setting is selected.

Settings	Descriptions
A/BC	Part A on the left section and Part B and C on the right section of the keyboard
AB/C	Part A and B on the left section and Part C on the right section of the keyboard
A/B/C	Part A on the left section, Part B on the center section, and Part C on the right section of the keyboard
ABC	Voices on Part A, B, and C are layered

The Split setting can be changed from the [SETTINGS] button → *Sound* → *Common* → *Layer/Split* → *Mode* (page 30).

### 21 [SPLIT POINT] button

For viewing the screen for changing the Split Point or the lowest note on the right section.  
 Turn the Encoder dial or simply press the key you wish to assign as the Split Point.  
 Settings made here are stored in the Live Set Sound.

#### NOTE

- The Split Point can be set by simultaneously pressing the [SPLIT POINT] button and the key you wish to assign as a Split Point.
- The Split Point can be changed from the [SETTINGS] button → *Sound* → *Common* → *Layer/Split* → *Split Point* (page 30).

### 22 CATEGORY buttons

For selecting a Voice from the Voice Category to use for the Part.  
 Every time you press the same button, the cursor moves to the next Voice in the same Category. Quickly pressing the button twice displays the Voice list.  
 The Organ voices using the Organ Flutes tone generator (H, V, F, A, and Y) are available from the [Organ] button. These voices can be set using the ORGAN FOOTAGE sliders, PERCUSSION buttons, and VIBRATO/CHORUS buttons.

Types	Descriptions
H	A distinctive electric organ from the 1960s, characterized by sine-like waveforms that are simple yet warm. This type of organ was used in many genres of music, such as rock, pop, and jazz.
V	A transistor organ from the 1960s. With harmonic content very close to that of a square wave, it had a sound of great presence. This type of organ was often used in psychedelic rock and ska.
F	A transistor organ from the 1960s. This type of organ is notable for its thick sound with the sawtooth components boosted in volume. It was often used in 60s pop music and alternative pop of the 90s.
A	A transistor organ made in Japan during the 1970s. This type of organ was notable for a bright sound similar to that produced by the sawtooth waveforms of a synthesizer.

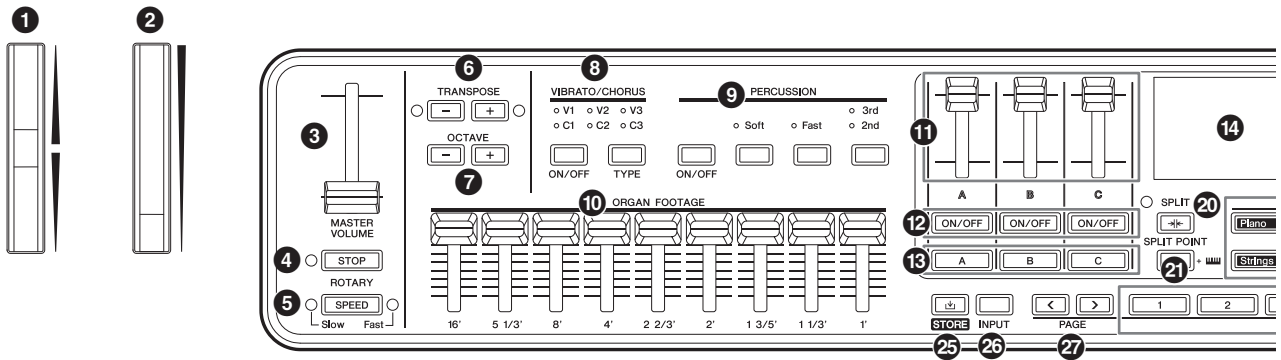

Type	Descriptions
Y	A Yamaha transistor organ released in 1972. With harmonic content very close to that of a square wave, it was characterized by significant presence in the high range and extreme sound clipping with increased distortion.

### 23 MONO-TYPE buttons

For setting the tone generation mode for the selected Part.

Use the [MONO] button to switch between *Mono* and *Poly*. The *Mono* mode is for playing a single note at a time and the *Poly* mode is for playing chords. Use the MONO [TYPE] button to select the *Mono* mode type. This also features Portamento types commonly used for classic pitch slides in synth lead sounds.

Type	Descriptions
<i>Normal</i>	Simple <i>Mono</i> mode without Portamento
<i>Fingered Portamento</i>	<i>Mono</i> mode with Portamento used only while playing legato
<i>Full-Time Portamento</i>	<i>Mono</i> mode with Portamento used even when lifting your fingers from the keyboard

#### NOTE

- The time and mode for Portamento can be changed from the [SETTINGS] button → *Sound* → *Part* → *Mono/Portamento* (page 28).
- Simultaneously press the [ENTER] and MONO [TYPE] buttons to view the screen for the Portamento time setting (page 42).

### 24 UNISON-TYPE buttons

For setting *Unison* for the selected Part.

Use the [UNISON] button to turn the *Unison* mode on or off, and the UNISON [TYPE] button to select a *Unison* type. When the *Unison* mode is on, the Part sounds are layered to make them sound richer and thicker. In this *Unison* function, the Part sounds including the Insertion Effects are layered.

Type	Description
<i>Multi Layer</i>	<i>Unison</i> that layers the Part sound played on the keyboard
<i>Harmonics</i>	<i>Unison</i> that layers the Part sound played on the keyboard at one octave higher
<i>Sub Harmonics</i>	<i>Unison</i> that layers the Part sound played on the keyboard at one octave lower

Change the *Unison volume* and *Detune* setting from the [SETTINGS] button → *Sound* → *Part* → *Unison* (page 28).

#### NOTE

Simultaneously press the [ENTER] and UNISON [TYPE] buttons to view the screen for the *Unison Detune* setting (page 42).

### 25 [STORE] button

For saving (storing) the edited Live Set Sound.

When storing, the following settings are saved to the internal memory of the keyboard.

Stored settings will be retained when the CK is turned off.

- Voices on Part A–C
- Organ voice settings (Rotary Speaker, Vibrato/Chorus, and Percussion)
- Filter
- EG
- Drive
- Effect1 and Effect2
- Delay
- Reverb
- [SETTINGS] (including Split and Transpose)

#### NOTE

EQUALIZER settings are stored to a Live Set Sound if *Live Set EQ* is set to *On* (page 30).

### 26 [INPUT] button

For setting the volume and effects for the audio input from the A/D INPUT jack.

Pressing this button shows the same screen as pressing the [SETTINGS] button → *A/D Input*.

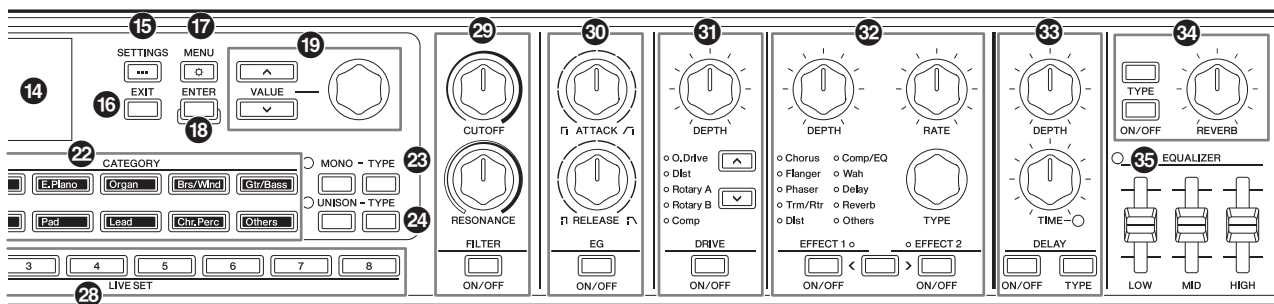

### 27 PAGE buttons

For switching the Live Set Page. The Live Set Sound changes accordingly. Simultaneously press the [ $\leftarrow$ ] and [ $\rightarrow$ ] buttons to call up the Live Set View. In the Live Set View, you can use the VALUE buttons and the Encoder Dial to select a Live Set Sound from a different Live Set Page. To go back to the Top screen, press the [EXIT] button.

### 28 LIVE SET [1]–[8] buttons

For calling up a Live Set Sound from the eight of the Live Set Sounds in the currently selected Live Set Page. Change the Live Set Page using the PAGE button.

### 29 FILTER [ON/OFF] button FILTER [CUTOFF] knob FILTER [RESONANCE] knob

For applying a filter to the currently selected Part. By setting the [ON/OFF] button to *off*, the filter is instantly reset to the initial value for the Voice.

#### [CUTOFF] knob

For setting the cutoff frequency of the low-pass filter. The sound can be brightened by moving the knob to the right or darkened by moving it to the left.

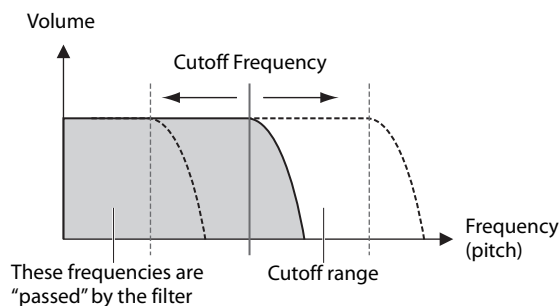

#### NOTE

How the filter is applied varies depending on the Voice being used.

### [RESONANCE] knob

For setting the resonance, which changes the character of the sound. This effect can be made more pronounced by moving the knob to the right and less pronounced by moving it to the left.

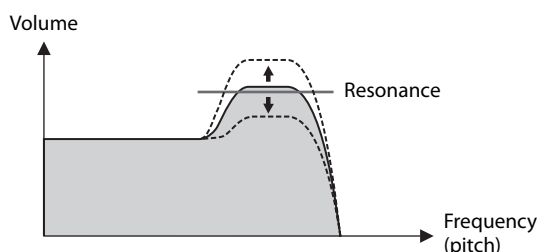

### 30 EG [ON/OFF] button EG [ATTACK] knob EG [RELEASE] knob

For applying an EG (Envelope Generator) to the currently selected Part. By setting the [ON/OFF] button to *off*, the EG is instantly reset to the initial value for the Voice.

#### [ATTACK] knob

For adjusting the attack for the EG. Turn the knob to the left to make the attack faster, and to the right to make the attack slower.

#### [RELEASE] knob

For adjusting the release for the EG. Turn the knob to the left to make the release faster, and to the right to make the release slower.

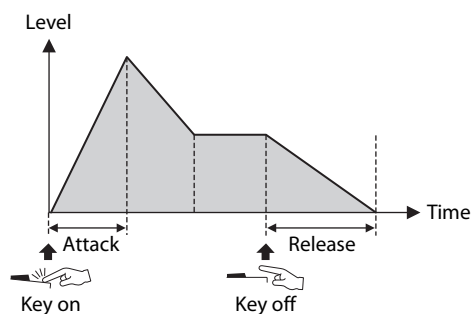

#### NOTE

How the EG is applied varies depending on the Voice being used.

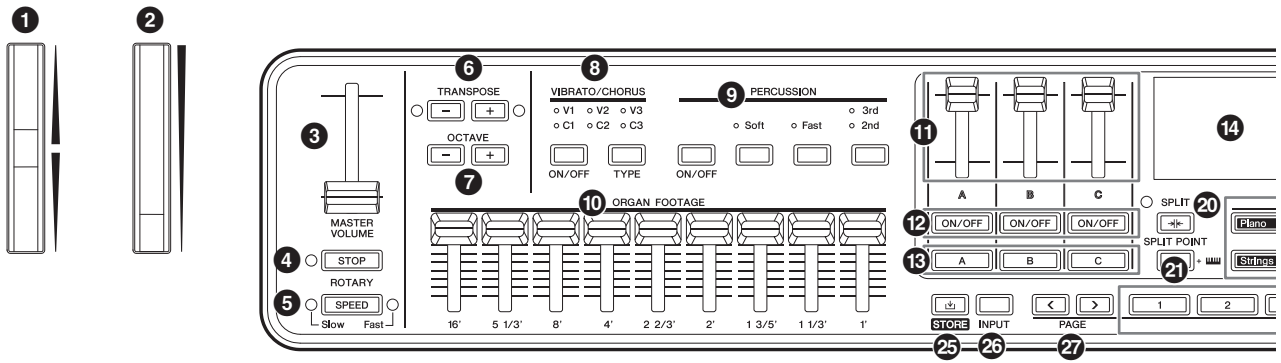

**31 DRIVE [ON/OFF] button**  
**DRIVE [DEPTH] knob**  
**Drive type select buttons**

For setting Drive, which applies an overdrive effect to the currently selected Part. Use the [ON/OFF] button to turn Drive on or off, and use the [DEPTH] knob to adjust values. Use the Drive Type select buttons to select a type.

Type	Description
<i>O.Drive</i>	Warm distortion effect (overdrive)
<i>Dist</i>	Hard rock distortion
<i>Rotary A</i>	Standard rotary speaker for organ.
<i>Rotary B</i>	The rotary speaker connected to a transistor preamplifier with strong distortion.
<i>Comp</i>	Versatile compressor controlled by a single knob

**32 EFFECT 1 [ON/OFF] button**  
**EFFECT 2 [ON/OFF] button**  
**EFFECT [DEPTH] knob**  
**EFFECT [RATE] knob**  
**EFFECT [TYPE] knob**  
**EFFECT1–EFFECT2 select button**

For applying Insertion Effects to the currently selected Part. The Insertion Effects are applied in a path to Effect 1 and then to Effect 2.

Use the [ON/OFF] button to turn the Effect on or off, and use the EFFECT1–EFFECT2 select button to select EFFECT1 or EFFECT2. The [TYPE] knob is used to select a type, the [DEPTH] knob to adjust the Insertion Effect depth, and the [RATE] knob to adjust the Insertion Effect rate.

**NOTE**

Simultaneously press the [ENTER] and EFFECT1–EFFECT2 select buttons to swap the EFFECT 1 and EFFECT 2 settings. This conveniently lets you change the order of the applied effects (page 42).

There are various types of Insertion Effects with different characteristics. There are 10 effect type categories available. The category lamp for the selected effect type lights up.

Category	Description
<i>Chorus</i>	Adds spaciousness and thickness to the sound, as if multiple sounds are played at once.
<i>Flanger</i>	Creates metallic sweeping sounds like a jet plane.
<i>Phaser</i>	Creates a phase-shifting effect that uses feedback circuitry as well as phase shift circuitry that mixes the phase-shifted sound with the original sound.
<i>Trm/Rtr</i>	<i>Trm</i> (Tremolo) is an effect that cyclically modulates the volume. <i>Rtr</i> (Rotary Speaker) is an effect that simulates a rotary speaker, which is popular for Organ sounds.
<i>Dist</i>	An effect that distorts sounds.
<i>Comp/EQ</i>	<i>Comp</i> (compressor) is an effect that compresses loud sounds or boosts soft sounds to even out the dynamics of the audio signal. <i>EQ</i> is an effect that changes the tonal character of the sound.
<i>Wah</i>	Creates a characteristic “wah-wah” sound by changing the frequency response of the filter.
<i>Delay</i>	Creates echo effects by delaying the time of the input sound.
<i>Reverb</i>	Creates a sense of space and ambience by artificially producing complex echoes.
<i>Others</i>	Other types of effects that are not included in the above categories.

For more information on the effect types, see the “Effect list” on page 43.

**NOTE**

By holding down the [ENTER] button and operating the EFFECT [TYPE] knob, you can select the first item of the previous or the next category. This is convenient for quickly finding the category you wish to use (page 42).



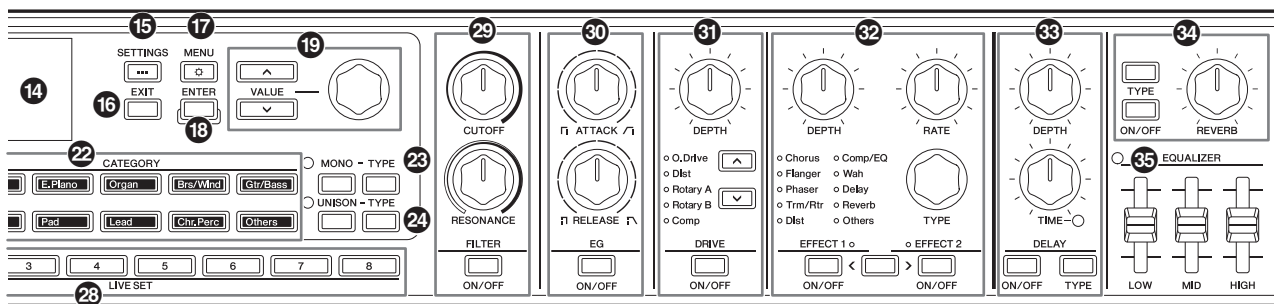

**33 DELAY [ON/OFF] button**  
**DELAY [TYPE] button**  
**DELAY [DEPTH] knob**  
**DELAY [TIME] knob**

Use the [ON/OFF] button to turn the Delay on or off. Use the [TYPE] button to select a type, the [DEPTH] knob to set the delay depth, and the [TIME] knob to adjust the delay length.

Type	Description
<i>Digital Delay</i>	Clean digital delay Use the [DEPTH] knob to adjust the depth and feedback level, and the [TIME] knob to adjust the delay time.
<i>Analog Delay</i>	Delay with warm analog sound Use the [DEPTH] knob to adjust the feedback level and the [TIME] knob to adjust the delay time.
<i>Cross Delay</i>	Delay that crosses the delay sound from left to right and from right to left Use the [DEPTH] knob to adjust the depth and feedback level, and the [TIME] knob to adjust the speed.
<i>Tempo Delay</i>	A special delay that syncs to the tempo of the song. The delay is applied by specifying the Tempo ( <i>Tempo Delay Time</i> ) and the note length. The initial value is 1/4 (quarter note).  Use the [DEPTH] knob to change the delay depth and feedback level, and the [TIME] knob to adjust the delay tempo. Another intuitive way of setting the tempo is to tap the [ENTER] button at least three times.  <i>Tempo Delay Time</i> can be set by using the [TIME] knob while holding down the [ENTER] button (page 42), or from the [SETTINGS] button → <i>Sound</i> → <i>Common</i> → <i>Tempo Delay Time</i> .

**34 REVERB [ON/OFF] button**  
**REVERB [TYPE] button**  
**REVERB DEPTH knob**

Use the [ON/OFF] button to turn the Reverb on or off. Use the [TYPE] button to select a type and the REVERB DEPTH knob to adjust the reverb depth.

Type	Description
<i>Hall Reverb</i>	Simulates the sound of a concert hall.
<i>Room Reverb</i>	Simulates the sound of a room.
<i>Plate Reverb</i>	Simulates the sound of a plate reverb.

**35 EQUALIZER slider**

For adjusting the Master EQ. The lamp turns on when the slider value is set to a value other than 0.

Set the Frequency for each type from the [MENU] button → *General* → *System* → *Master EQ* (page 36).

[HIGH]	Gain for the high-frequency band (500 Hz–16 kHz)
[MID]	Gain for the mid-frequency band (100 Hz–10 kHz)
[LOW]	Gain for the low-frequency band (32 Hz–2 kHz)

EQUALIZER settings are stored to a Live Set Sound if *Live Set EQ* is set to *On* (page 30).

The *Live Set EQ* setting is changed from the [SETTINGS] button → *Sound* → *Common* → *Live Set EQ* (page 30).

## Rear panel

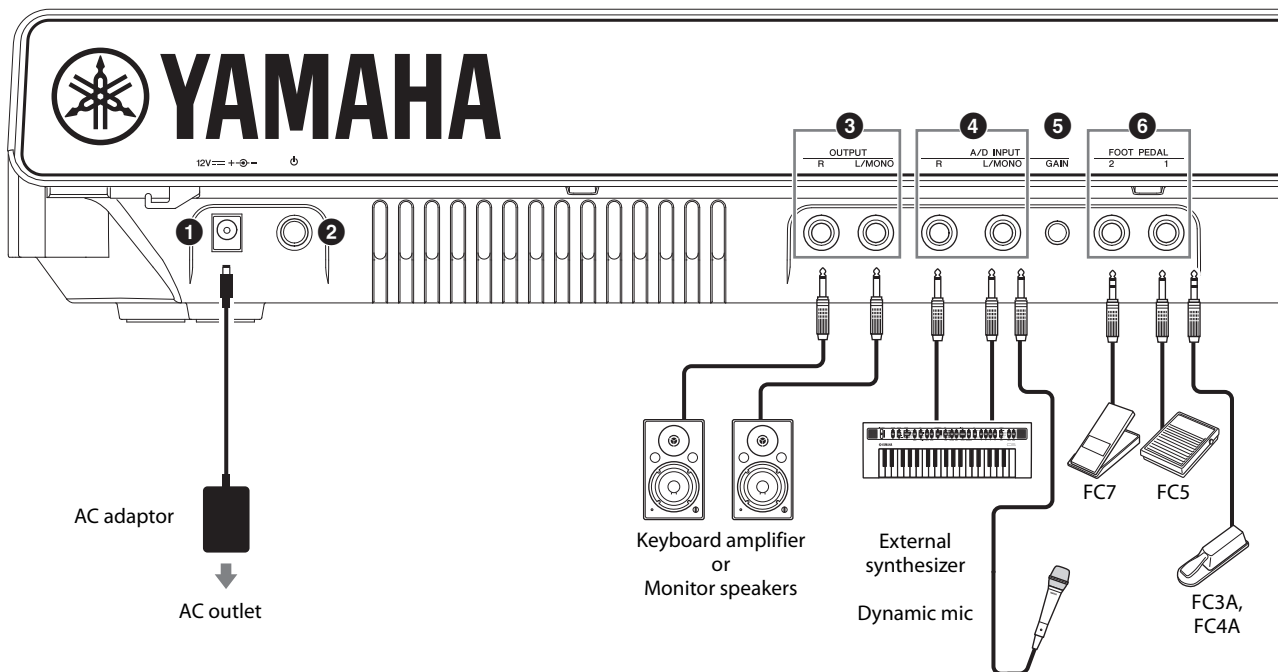

### 1 [DC IN] jack (page 20)

For connecting the included AC adaptor.

### 2 [⏻] (STANDBY/ON) switch (page 22)

For switching the CK to standby (■) or turning it on (■).

### 3 OUTPUT jacks

Standard phone (unbalanced) jacks for outputting audio signals. For output in mono, connect only to the [L/MONO] jack.

### 4 A/D INPUT jacks

Standard phone jacks (1/4" mono phone plug) for receiving audio from the external audio device. Musical instruments such as synthesizers, audio devices, such as portable music players, as well as dynamic microphones can be connected to these jacks, and the audio input signals can be played as an audio Part. In addition, the effects can be applied to external audio signals. The effect type can be set from the [INPUT] button.

To switch the input source (to *Line* or *MIC*), use the [MENU] button → *General* → *Audio* → *A/D Input Type*.

#### NOTE

The CK does not support phantom-powered condenser microphones.

### 5 A/D INPUT [GAIN] knob

The external audio source input via these jacks is mixed in with the sounds played by the CK. Use this knob to adjust the balance between the external audio and the CK sounds.

### 6 FOOT PEDAL jacks

For connecting a separately sold sustain pedal. The compatible pedals are Foot Pedal FC3A, Footswitch FC4A, Footswitch FC5, and Foot Controller FC7. Set the pedal type from the [MENU] button → *General* → *Foot Pedal*.

#### NOTE

When the pedal connected to the jack and the *Foot Pedal* setting do not match, the pedal may not work properly or may malfunction. Make sure to select the correct pedal type for the pedal connected to the jack.

You can assign functions such as sustain or sostenuto from the [SETTINGS] button → *Controllers* → *Foot Pedal 1* or *Foot Pedal 2* → *Assign* (page 31).

### 7 SPEAKERS switch

For tuning the built-in speakers on or off. If this switch is on and the *Speaker Mute* is set to *Auto*, the built-in speakers will automatically be muted when the headphones are connected.

To change the *Speaker Mute* setting, set from the [MENU] button → *General* → *System* → *Speaker* → *Speaker Mute*.



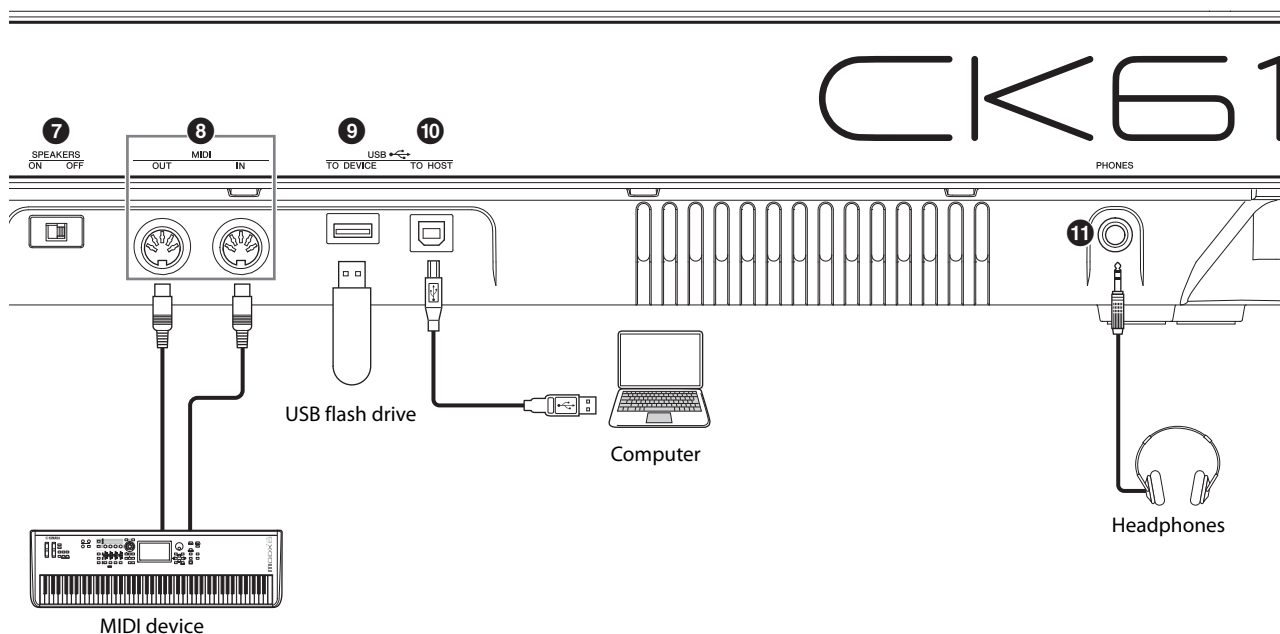

## 8 MIDI terminals

With a standard MIDI cable (commercially available), you can connect an external MIDI instrument, and control it from the CK. Likewise, you can use an external MIDI device (such as a keyboard or sequencer) to control the internal tone generator on the CK.

## 9 USB [TO DEVICE] terminal

For connecting a USB flash drive to the CK, allowing you to save a Live Set Sound you have stored, load a Live Set Sound back to the CK, or play audio files.

### NOTE

- Only a USB flash drive can be connected to the USB [TO DEVICE] jack. No other USB devices such as a hard disk drive, CD-ROM drive, or USB hub can be used.
- You cannot record your performance onto a USB flash drive.

## 10 USB [TO HOST] terminal

For connecting the CK to a computer, iPhone, or iPad via a USB cable for using the MIDI and audio capability. With the USB [TO HOST] terminal, two MIDI ports (page 48) can be used simultaneously.

### NOTE

The USB [TO HOST] terminal has the capacity for handling two mono channels (or one stereo channel) of 24-bit audio at a sampling rate of 44.1 kHz.

## 11 [PHONES] jack

For connecting a 6.3-mm standard stereo phone jack to connect headphones.

When the *Speaker Mute* is set to *Auto*, the built-in speakers will be muted when the headphones are connected.

### CAUTION

- To prevent hearing loss, avoid using headphones at high volumes for extended periods of time.
- Whenever connecting external audio devices, ensure that all devices are turned off.

### NOTE

The sound output via the headphones is identical to that output via the OUTPUT jacks. The sound is output via OUTPUT jacks regardless of whether or not the headphones are connected.

The [PHONES] jack on the CK88 can be found on the front side.

For CK88

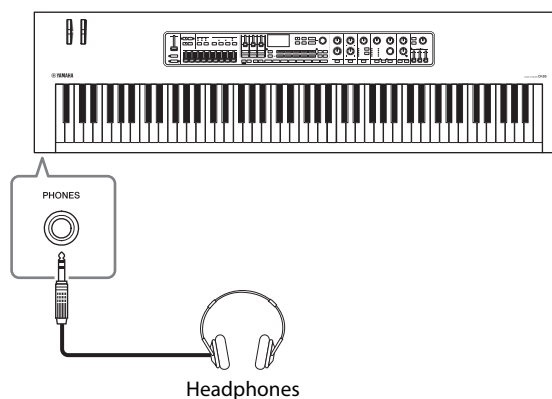

# Setting up

Although the CK will run either from an AC adaptor or batteries, Yamaha recommends the use of an AC adaptor whenever possible. An AC adaptor is more environmentally friendly than batteries and does not deplete resources.

## NOTICE

It is recommended to use the AC adaptor when executing USB flash drive operations, since battery power may not be reliable enough to last through these crucial operations.

## Using an AC adaptor

Make sure that the [⏻] (Standby/On) switch is in a standby position (the switch is up), then connect the AC adaptor in the order shown in the illustration.

1. Wrap the DC output cable of the AC adaptor around the cord hook (as shown below), and then connect the plug of the adaptor to the DC IN jack on the rear panel.

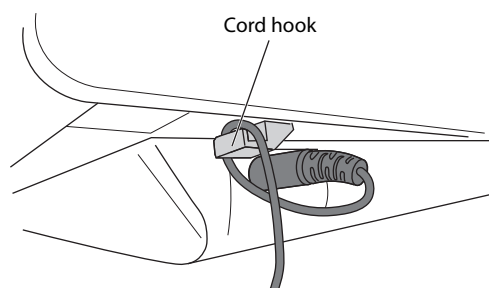

## NOTICE

Use of the cord hook prevents accidental unplugging of the cable during operation. Make sure to avoid tightening the cord more than necessary or pulling on the cord strongly while it is wrapped around the cord hook, in order to prevent wear on the cord or possible breakage of the hook.

2. Connect the other end of the AC adaptor to an AC outlet.

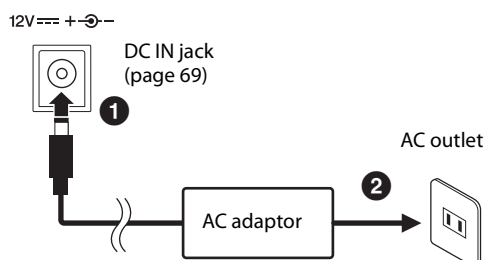

## WARNING

- Use the specified AC adaptor (page 69) only. Using the wrong AC adaptor can result in damage to the instrument or overheating.
- When using the AC adaptor with a removable plug, make sure to keep the plug attached to the AC adaptor. Using the plug alone can cause electric shock or fire.
- If the plug is accidentally removed from the AC adaptor, never touch the metallic section when attaching the plug. To avoid electric shock, short circuit, or damage, also be careful that there is no dust between the AC adaptor and plug.

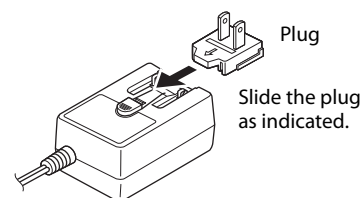

The shape of the plug differs depending on your area.

## CAUTION

When setting up the product, make sure that the AC outlet you are using is easily accessible. If some trouble or malfunction occurs, immediately turn the power off and disconnect the plug from the outlet.

## NOTE

- Follow the order shown above in reverse when disconnecting the AC adaptor.
- When the AC adaptor is connected, the adaptor is used for supplying power to the instrument regardless of whether or not the batteries are installed to the instrument.
- Do not insert or remove the DC plug with the [⏻] (Standby/On) switch set to the On position (⬇️). Failure to observe this precaution can lead to malfunction.

## Using batteries

The CK requires eight "AA" size, Alkaline (LR6) or rechargeable nickel-metal hydride batteries (rechargeable Ni-MH batteries).

Use of the AC adaptor is recommended when keeping the CK on for an extended time.

1. Make sure that the CK is turned off.
2. Turn the CK over and place the top side on a soft cloth.

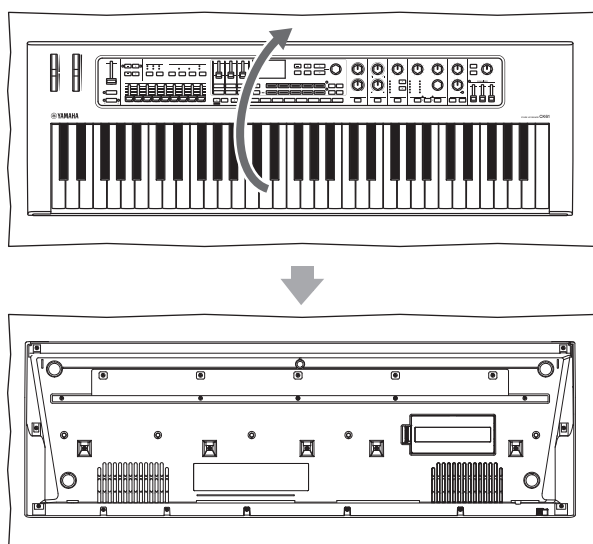

The bottom of the CK

3. Open the battery compartment cover.

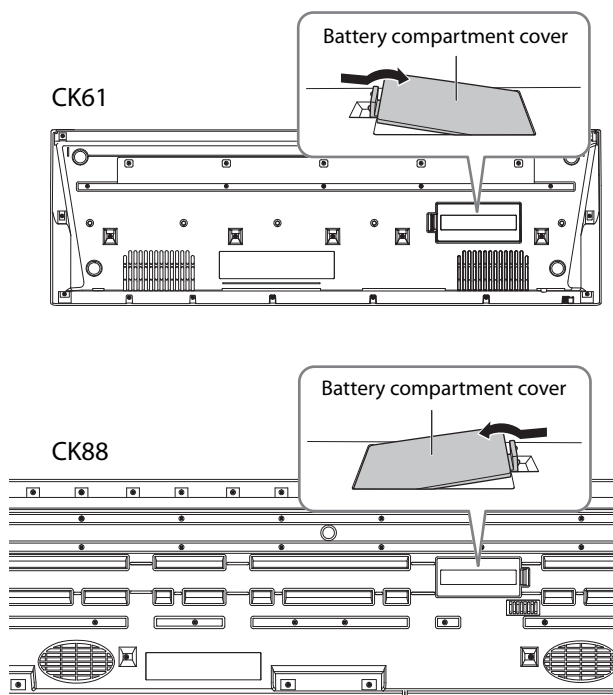

4. Insert the eight new batteries, being careful to follow the polarity markings on the inside (or next to) the compartment.

CK61

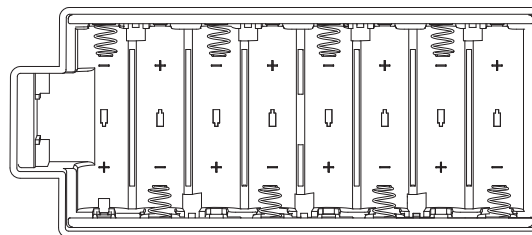

CK88

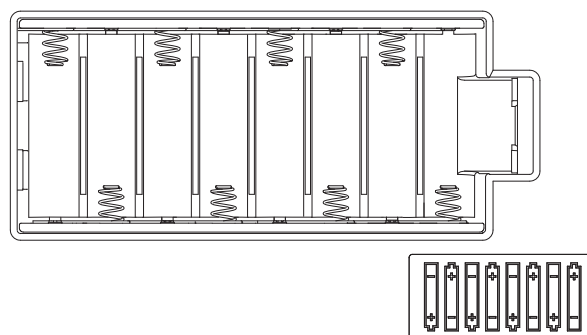

5. Close the compartment cover until it clicks into place.

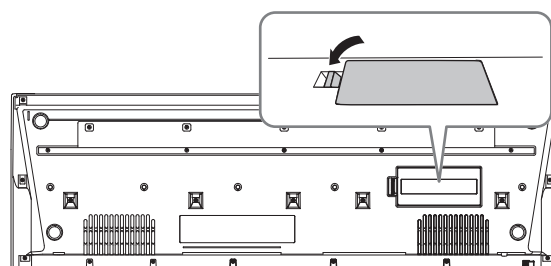

6. Turn the CK face up.

Do not leave the CK with the front panel side down.



### NOTICE

- Connecting or disconnecting the AC adaptor with batteries installed may turn the power off, resulting in loss of data being edited at the time.
- When battery power becomes too low for proper operation, the volume may be reduced, the sound may be distorted, and other problems may occur. When this happens, make sure to replace all batteries with new ones or already recharged ones.

### NOTE

- This instrument cannot be used to charge the batteries. Use only the specified charger device when charging.
- Power will be automatically drawn from the AC adaptor if an AC adaptor is connected while batteries are installed in the instrument.

## ■ Remaining battery power indication

Indication	Description
	Indicates that the remaining power is sufficient.
	Indicates that the remaining power is insufficient for operation. The built-in speakers will be turned off after this indication is shown. Save the settings you are editing and replace all the batteries with new ones.

## Turning the power on Turning the power off

Make sure the volume settings of the CK and external devices such as powered speakers are turned down to the minimum before turning the power on. When connecting the CK to monitor speakers, turn on the power switch on each device in the following order.

### ■ Turning on

Turn the [MASTER VOLUME] slider of the CK to its minimum → set the [⏻] (STANDBY/ON) switch to on (⏻). → turn the amplifier or speaker power on.

### ■ Turning off

Turn the [MASTER VOLUME] slider of the CK to its minimum → turn the amplifier or speaker power off → set the [⏻] (STANDBY/ON) switch to standby (⏻).

## Setting the Auto Power Off function

The *Auto Power Off* function automatically turns off the CK after 30 minutes of inactivity. As a factory default, *Auto Power Off* is set to *Auto*.

With the *Auto* setting, the *Auto Power Off* function is disabled while the AC adaptor is being used, and enabled while the batteries are being used.

### NOTICE

- The setting will revert to its default value if not backed up before the power is turned off. Make sure to store the settings before the *Auto Power Off* function becomes activated (page 24).
- When the instrument is not operated for a specified period of time while connected to an external device such as an amplifier, speaker, or computer, make sure to follow the instructions in the Owner's Manual to turn off the power to the instrument and the connected devices in the proper sequence, in order to protect the devices from damage. If you do not want the power to turn off automatically when a device is connected, disable *Auto Power Off*.

## ■ Auto Power Off setting

Change the setting from the [MENU] button → *General* → *System* → *Auto Power Off* (page 36).

## Connecting headphones

Connect a pair of headphones to the [PHONES] jack.

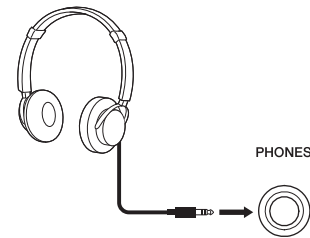

Standard stereo phone plug

When a set of headphones are connected while the *Speaker Mute* is set to *Auto*, the built-in speakers will be muted. When set to *Manual*, the built-in speakers will be muted by setting the SPEAKERS switch on the rear panel to OFF.

The setting can be changed from the [MENU] button → *General* → *System* → *Speaker*.

While the built-in speakers are muted, the output from the [PHONES] jack will also be output from OUTPUT jacks.



### CAUTION

- Do not use the headphones for a long period of time at a high volume level, since this can cause permanent hearing loss.
- Before connecting the instrument to other electronic components, turn off the power of all the components. Also, before turning any components on or off, make sure to set all volume levels to a minimum. Otherwise, damage to the components or electrical shock may occur.

### NOTICE

To avoid possible damage to the external device, first turn on the power to the instrument, and then to the external device. When turning off the power, do so in reverse order: first turn off the power to the external device, and then to the instrument.

## Using a USB flash drive

By connecting a USB flash drive to the USB [TO DEVICE] terminal on the rear panel, you can save the Live Set Sounds as backup files or load settings back from the backup files.

### Precautions when using the USB [TO DEVICE] terminal

When connecting a USB flash drive to the USB [TO DEVICE] terminal, be sure to follow the important precautions shown below.

#### NOTE

For more information on the handling of the USB flash drives, refer to the Owner's Manual of your USB flash drive.

#### ■ Compatible USB devices

- USB flash drives only

Other USB devices such as a USB hub, computer keyboard, or mouse cannot be used.

The instrument does not necessarily support all commercially available USB devices. Yamaha cannot guarantee the operation of USB devices that you purchase. Before purchasing a USB device for use with this instrument, please visit the following web page: <https://download.yamaha.com/>

Although USB 1.1 and 2.0 devices can be used on the CK, the amount of time for saving to or loading from the USB flash drive may differ depending on the type of data or the status of the instrument.

#### NOTICE

**The rating of the USB [TO DEVICE] terminal is a maximum of 5 V / 500 mA. Do not connect USB devices having a rating above this, since this can cause damage to the instrument itself.**

#### ■ Connecting a USB flash drive

When connecting a USB flash drive to the USB [TO DEVICE] terminal, make sure that it is connected in the proper direction.

#### NOTICE

- **Avoid connecting or disconnecting the USB device during file management operations (such as Save, Copy, Delete, and Format), or when accessing the USB flash drive. Failure to observe this may result in "freezing" of the operation of the instrument or corruption of the USB flash drive.**
- **When connecting then disconnecting the USB flash drive (and vice versa), make sure to wait a few seconds between the two operations.**
- **Do not use cables for connecting the USB flash drive.**

#### ■ Formatting the USB flash drive

Some USB flash drives should be formatted with this instrument before they can be used (page 36). The USB flash drives formatted on other instruments or devices may not work properly.

#### NOTICE

**The format operation erases any existing files. Make sure that the USB flash drive you are formatting does not contain any important files.**

#### ■ To protect your files (Write Protection)

To prevent important files from being inadvertently erased, write-protect the USB flash drive. When you are saving files to the USB flash drive, make sure you disable the write-protection first.

#### ■ Turning off the instrument

When turning off the instrument, make sure that the instrument is NOT accessing the USB flash drive by file management (such as during Save, Copy, Delete and Format operations). Failure to do so may corrupt the USB flash drive and the files.

# Basic operations

## Top screen configuration

This section explains the Top screen which appears when the CK is turned on.

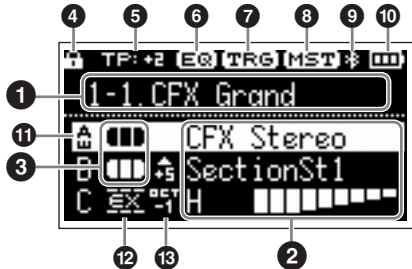

### 1 Live Set Sound number

Shows the currently selected Live Set Sound number. With the initial setting, number 1-1 will be called up at startup.

To use a different Live Set Sound number for startup, change the setting from the [MENU] button → *General* → *System* → *Power on Sound* (page 36).

### 2 Voice

Shows the Voice name when the Part is on. With some Organ voices, the Voice name and the Drawbar settings will be shown.

### 3 Split and Layer

Shows the current split and layer status of each Part. The split point is the lowest key on the right keyboard range.

## Other icons

4		Panel lock is on. The setting can be changed by simultaneously pressing both the [ENTER] and [MENU] buttons.
5		Sound Transpose for the Live Set Sound is set to a value other than 0 (-12 to +12).
6		Live Set EQ is set to on.
7		Audio Trigger is set to ON.
8		Master Keyboard is set to ON.
9		Connected via Bluetooth.
10		Battery level (shown only during battery operation).
11		Touch Sensitivity for the Part has been changed. (For Part A)

12		External Keyboard for the Part is set to ExtOnly. Play the external keyboard to sound the internal tone generator.
13		Note Shift for the Part is set to a value other than 0 (±24). When the note value is -24, -12, +12, and +24, it is shown as OCT-2, OCT-1, OCT+1, and OCT+2.

## Creating a Live Set Sound

Use the Live Set Sound for sound-making.

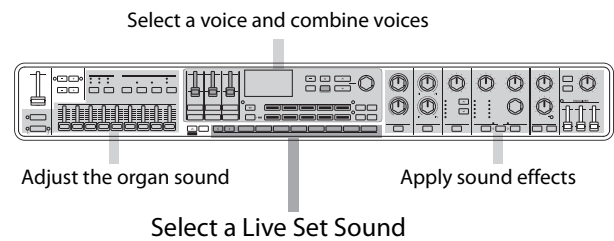

The basic sound-making procedures are as shown below.

1. Select a Live Set Sound.
2. Select a Voice for each Part.
3. Set a combination of these Voices.
4. Creating an Organ voice.
5. Modify sounds using EG, Filter, Effects, MONO, and Unison settings.
6. Save the Live Set Sound.

## Saving the Live Set Sound

Edited Live Set Sounds are saved to the internal memory of the CK by pressing the [STORE] button.

### 1. Press the [STORE] button.

A screen for selecting the Live Set Sound to be stored appears.



## 2. Use the Encoder dial to select the desired Live Set Sound number for saving to.

You can audition the Voice already saved to the Live Set Sound number by playing the keyboard before saving the new one.

### NOTICE

- The settings will be overwritten if you select the same number as an existing Live Set Sound.
- The settings currently editing will be lost if you select a different Live Set Sound or turn off the power before storing the settings.

## 3. Press the [ENTER] button to store.

When the store operation is complete, the message "Completed" will appear and operation returns to the Top screen.

If a different Live Set Sound Number was selected when saving the currently editing Live Set Sound, the Live Set Sound before the edit will be kept unchanged in the original Live Set Sound Number.

### NOTE

If you have accidentally changed to a different Live Set Sound causing your edits to be lost, you can use the *Edit Recall* function to recall the last edited status (page 40).

## Other Live Set Sound features

These powerful and convenient features for Live Set Sound let you apply effects to the audio input via A/D input or play back an audio file while performing on the keyboard.

## Applying effects to audio signals from the A/D INPUT jacks

You can connect another electronic musical instrument, guitar, or a microphone to the A/D INPUT jacks, and apply dedicated effects to those external audio sources.

Here, we'll cover how to use a dynamic microphone.

### 1. Connect a dynamic mic to the A/D Input [L/MONO] jack on the rear panel.

Example for a dynamic mic

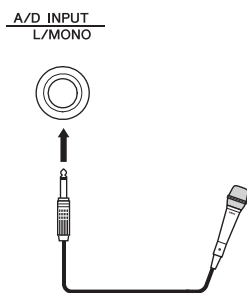

### 2. Select Mic from the [MENU] button → General → Audio → A/D Input Type.

### 3. Press the [INPUT] button.

The *A/D Input* screen appears.

### 4. Select an effect type from the Input Effect1 or Input Effect2 TYPE.

This completes the setup.

Press the [STORE] button to save the *A/D Input* settings to the Live Set Sound.

## Playing back an audio file

While playing the Live Set Sound, you can play back an audio file saved on a USB flash drive using a single key on the keyboard.

### 1. Save the desired audio file (.wav) to the USB flash drive from a computer.

The supported audio file is in .wav format (44.1 kHz, 16-bit, Stereo). Files of .wav format in 48-kHz or mono cannot be played back on the CK.

### 2. Insert the USB flash drive to the USB [TO DEVICE] terminal on the rear panel.

### 3. Select from the [SETTINGS] button → Function → Audio Trigger.

### 4. Change the settings.

- *Switch*: Set to ON
- *File*: Select the audio file to play back
- *Volume*: Set the playback volume
- *Key Assign*: Select the rightmost key or the leftmost key to start or stop playback.
- *Play Mode*: Sets the mode for playback

### 5. Press the key specified in Key Assign to start playback at the desired timing.

Playback then starts.

Set the mode for playing back audio files from *Play Mode*.

The *Play Mode* setting can be changed from the [SETTINGS] button → *Function* → *Audio Trigger* → *Play Mode* (page 32).

# Managing Live Set Sounds

## Editing Live Set Sound names

Select the desired Live Set Sound for which you wish to edit the name → [SETTINGS] button → *Name* → Edit the name → [ENTER] button → Select *Store*.

### NOTE

If “Do not store now” is selected, the Live Set Sound will not be stored, but the edited name will be retained.

### ■ Operations during name edit

Use the Live Set Sound [1] and [2] buttons to move the cursor to the position of the character you wish to edit. Use the VALUE buttons and Encoder dial to select characters, and then use other buttons as listed below to edit the name.

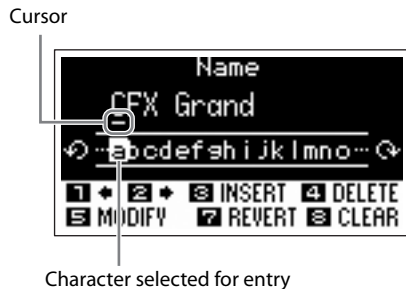

Buttons	Functions
LIVE SET [1] 1 +	Moves the cursor to left.
LIVE SET [2] 2 +	Moves the cursor to right.
LIVE SET [3] 3 INSERT	Inserts a highlighted character at the cursor position.
LIVE SET [4] 4 DELETE	Deletes the character at the cursor position.
LIVE SET [5] 5 MODIFY	Changes the highlighted character at the cursor position to the desired one.
LIVE SET [7] 7 REVERT	Reverts all characters to the unedited name.
LIVE SET [8] 8 CLEAR	Deletes all characters.
[ENTER]	Saves the name and ends editing.
[EXIT]	Ends editing without saving the name.

## Swapping or copying Live Set Sounds

1. Call up the Live Set Sound you want to swap from or copy from.
2. Use the [MENU] button → *Job* → *Live Set Manager* → *Swap* or *Copy*.
3. Use the Encoder dial to select the desired Live Set Sound to swap to or to copy to.



4. Press the [ENTER] button.

When the operation is completed, the message “Completed” appears on the screen, and then operation returns to the Top screen.

## Initializing a Live Set Sound

When initializing a Live Set Sound, only Part A is enabled (set to ON), and the first Voice in the Piano category will be selected. All settings for Filters, EG, and effects will be reset to their initial values.

1. Call up the Live Set Sound you want to initialize.
2. Select from the [MENU] button → *Job* → *Live Set Manager* → *Initialize*.
3. Use the Encoder dial to select *Live Set Sound Init*.
4. Press the [ENTER] button.

When initialization is complete, the message “Completed” appears on the screen, and then operation returns to the Top screen.

### NOTE

If you want to reset the Live Set Sound to the default settings, simultaneously press the [EXIT] and [SETTINGS] buttons (page 42). This operation does not overwrite the stored Live Set Sound.



## Saving the Live Set Sound to a USB flash drive

The Live Set Sound stored in the internal memory of the CK can be saved to a USB flash drive as a backup file.

Before using a USB flash drive, be sure to read “Precautions when using the USB [TO DEVICE] terminal” (page 23).

1. Connect a USB flash drive to the USB [TO DEVICE] terminal of the CK.
2. Select the [MENU] button → *File*.
3. Select the type of file you wish to save.

File type	Description
<i>Back Up File</i>	All Live Set Sounds including the settings for the entire instrument.
<i>Live Set All File</i>	All Live Set Pages.
<i>Live Set Page File</i>	Currently selected Live Set Page.
<i>Live Set Sound File</i>	Currently selected Live Set Sound.

4. Select *Save* and press the [ENTER] button to call up the screen for selecting the destination.

- **When saving as a new file**  
Select *New File*.
- **When overwriting an existing file**  
Select the desired file from the displayed list.

5. Press the [ENTER] button.

The *Save \*\*\* File* screen for editing file name appears. For details on name editing operations, see “Operations during name edit” (page 26).

6. Press the [ENTER] button to save.

When the save operation is complete, a “Completed” message appears in the display, and then operation returns to the Top screen.

## Changing a previously saved file name

[MENU] button → *File* → *File Utility* → *Rename* → Select the desired file for which you wish to edit the name → Edit the name → [ENTER] button to save the file.

## Loading a Live Set Sound from a USB flash drive

For file types other than a *Live Set Sound File*, you can select and load a single desired Live Set Sound included in the file.

To do this, select *Load Live Set Sound* in step 6 to call up the screen for selecting a specific Live Set Sound in the file. Then select the desired Live Set Sound to load. The setting is loaded into the currently selected Live Set Sound number.

### NOTICE

The Load operation overwrites the Live Set Sounds stored in the CK. Important settings should always be saved to a USB flash drive.

1. Connect a USB flash drive to the USB [TO DEVICE] terminal of the CK.
2. Select the [MENU] button → *File*.
3. Select the type of file you wish to load from the USB flash drive.

File type	Description
<i>Back Up File</i> (Extension .Y1A)	All Live Set Sounds including the settings for the entire instrument.
<i>Live Set All File</i> (Extension .Y1L)	All Live Set Pages.
<i>Live Set Page File</i> (Extension .Y1P)	One Live Set Page. The file will be loaded to the currently selected Live Set Page.
<i>Live Set Sound File</i> (Extension .Y1S)	One Live Set Sound. The file will be loaded to the currently selected Live Set Sound.

4. Select *Load* and press the [ENTER] button.

5. Select the file in the USB flash drive.

To cancel the load operation, select *Cancel* and press the [ENTER] button.

6. Select *Load All* or *Load to \*\*\** and then press the [ENTER] button.

When the load operation is complete a “Completed” message appears in the display, and then operation returns to the Top screen.

# Advanced settings

## Live Set (SETTINGS button)

From the [SETTINGS] button, you can configure and store the various settings of the currently selected Live Set Sound. After editing, make sure to save the settings by pressing the [STORE] button. The changes made here will be stored to the Live Set Sound.

### Operation

**1. Press the [SETTINGS] button.**

**2. Use the VALUE buttons and Encoder dial to select an item, and then press the [ENTER] button.**

#### NOTE

You can also use the LIVE SET buttons [1] to [6] to select the item. The LIVE SET buttons [1] to [6] correspond to the items shown on the display in order from the top. The buttons light up when this feature is available.

**3. Use the VALUE buttons or Encoder dial to change the value, and then press the [ENTER] button.**

When the setting has been changed, the operation goes back to the previous screen for selecting the settings item.

## Sound

Function name			Description
Part A	Mono/	Mono/Poly	Selects whether to play the Part as monophonic ( <i>Mono</i> ) or polyphonic ( <i>Poly</i> ). <b>Default:</b> <i>Poly</i>
Part B	Portamento		
Part C		Type	Determines how the portamento effect is used depending on how you play the keys. <ul style="list-style-type: none"> <li>• <i>Normal</i>: The normal mono sound is played. Portamento is not used.</li> <li>• <i>Fingered</i>: Portamento is used only when you play legato (playing a key while still holding the previous key).</li> <li>• <i>Full-time</i>: Portamento is always used.</li> </ul> <b>Default:</b> <i>Normal</i>
		Portamento Time	Determines the speed or time that takes for the portamento pitch change. <b>Settings:</b> 0–127
		Portamento Time Mode	Determines the time standard for portamento pitch change. <ul style="list-style-type: none"> <li>• <i>Rate</i>: The pitch changes at the specified speed.</li> <li>• <i>Time</i>: The pitch changes over the specified time.</li> </ul> <b>Default:</b> <i>Rate</i>
Unison	Switch		Enables or disables the Unison function.
		Type	Selects a Unison type. <ul style="list-style-type: none"> <li>• <i>Multi Layer</i>: The Part sound played on the keyboard is layered</li> <li>• <i>Harmonics</i>: The Part sound played on the keyboard is layered at one octave higher</li> <li>• <i>Sub Harmonics</i>: The Part sound played on the keyboard is layered at one octave lower</li> </ul> <b>Default:</b> <i>Multi Layer</i>
		Volume	Adjusts the Part volume layered with the Unison function. <b>Settings:</b> 0–127
		Detune	Sets the amount of detuning between the Parts layered with the Unison function. By layering the detuned sounds, you can achieve a chorus-like effect. <b>Settings:</b> 0–127

Function name		Description
Part A Part B Part C	Note Shift	Shifts the keyboard pitch in semitones. <b>Settings:</b> -24+24 <b>Default:</b> +0 <b>NOTE</b> The value is not transmitted as a MIDI message.
Modulation	P.Mod Depth	Pitch Modulation cyclically changes the pitch. <i>P.Mod Depth</i> determines the pitch modulation depth. <b>Settings:</b> 0-127
	F.Mod Depth	Filter Modulation cyclically changes the cutoff frequency. <i>F.Mod Depth</i> determines the filter modulation depth. <b>Settings:</b> 0-127
	A.Mod Depth	Amplitude Modulation cyclically changes the volume. <i>A.Mod Depth</i> determines the amplitude modulation depth. <b>Settings:</b> 0-127
	Modulation Speed	Determines the modulation speed. This setting is applied commonly to <i>P.Mod</i> , <i>F.Mod</i> , and <i>A.Mod</i> . <b>Settings:</b> -64+0+63
Touch Sensitivity	Depth	Determines the degree to which the resulting volume of the tone generator responds to your playing strength. The higher the value, the more the volume changes in response to your playing strength (as shown below).  <div style="text-align: center;"> <p>When <i>Offset</i> (below) is set to 64</p> <p>The graph illustrates that as the modulation depth increases, the resulting velocity increases more sharply in response to playing strength. For a depth of 127, the resulting velocity is 127 regardless of the playing velocity. For a depth of 64, the resulting velocity is 64 at a playing velocity of 127. For a depth of 32, the resulting velocity is 32 at a playing velocity of 127. For a depth of 0, the resulting velocity is 0 at a playing velocity of 127.</p> </div>
		<b>Settings:</b> 0-127

Function name			Description
Part A	Touch	Offset	<p>Determines the amount by which played velocities are adjusted for the actual resulting velocity effect. This lets you raise or lower all velocities based on this setting value—allowing you to automatically compensate for playing too strongly or too softly. However, because of automatic compensation, the value will be set to 1 when the result is smaller than 1, and the value will be set to 127 when the result is larger than 127.</p> <div style="display: flex; justify-content: space-around;"> <div style="text-align: center;"> <p>When <i>Depth</i> = 64 and <i>Offset</i> = 32</p> </div> <div style="text-align: center;"> <p>When <i>Depth</i> = 64 and <i>Offset</i> = 64</p> </div> </div> <div style="text-align: center; margin-top: 10px;"> <p>When <i>Depth</i> = 64 and <i>Offset</i> = 96</p> </div>
Part B	Sensitivity		
Part C			
			<p><b>Settings:</b> 0–127</p>
Common	Transpose		<p>Changes the pitch up or down in semitones.</p> <p><b>Settings:</b> –12–+12</p> <p><b>Default:</b> +0</p> <p><b>NOTE</b> This setting does not affect MIDI output messages.</p>
	Layer/Split	Mode	<p>Selects the combination of Layer and Split. You can also use the [SPLIT] button for this setting.</p> <p><b>Settings:</b> ABC, A/BC, AB/C, A/B/C</p> <p><b>Default:</b> ABC</p>
		Split Point	<p>Sets the Split Point or the lowest note on the right keyboard range using a note name. When using the split mode A/B/C, two Split Points are needed. You can also use the [SPLIT] button to set the split point.</p> <p><b>Settings:</b> C#–2–G8</p> <p><b>Default:</b> G2</p> <p>C3 is MIDI note number 60.</p>
	Live Set EQ	Mode SW	<p>Turns the <i>Live Set EQ Mode</i> on/off.</p> <p><b>Default:</b> Off</p>
		EQ Settings	<p>Sets the EQ for the Live Set Sound.</p>
		High Gain	<p>Sets the gain for the high band.</p> <p><b>Settings:</b> –12 dB–0–+12 dB</p>
		High Frequency	<p>Sets the frequency for the high band.</p> <p><b>Settings:</b> 500 Hz–16 kHz</p>

Function name			Description	
Common	Live Set EQ	EQ Settings	<p><b>Mid Gain</b> Sets the gain for the mid-band. <b>Settings:</b> -12 dB–0–+12 dB</p> <hr/> <p><b>Mid Frequency</b> Sets the frequency for the mid-band. <b>Settings:</b> 100 Hz–10 kHz</p> <hr/> <p><b>Low Gain</b> Sets the gain for the low band. <b>Settings:</b> -12 dB–0–+12 dB</p> <hr/> <p><b>Low Frequency</b> Sets the frequency for the low band. <b>Settings:</b> 32 Hz–2.0 kHz</p>	
		<b>Tempo Delay Time</b>		<p>When <i>Tempo Delay</i> is selected for <i>Delay</i>, this sets the delay time in note lengths to match the tempo. <b>Settings:</b> 1/32 Tri.–1/2 <b>Default:</b> 1/4</p> <p><b>NOTE</b> The tempo should be set with the [TIME] knob or with <i>Tap Tempo</i> using the [ENTER] button.</p>

## Controllers



Function name			Description
Pitch Bend Range	Part A		Determines the pitch bend range in semitones. <b>Settings:</b> -24+0+24
	Part B		<b>Default:</b> +2
	Part C		
Mod Wheel Assign			<p>Determines the function to be assigned to the Modulation wheel. You can assign the Modulation wheel to Control Change numbers 1 to 119 or the <i>USB Audio volume</i>. <b>Settings:</b> Off, 1–119, <i>USB Audio Volume</i> <b>Default:</b> 1 (Modulation)</p>
Foot Pedal 1 Foot Pedal 2	Assign		<p>Determines the Control Change number to be assigned to a pedal connected to the FOOT PEDAL jack. You can assign each Foot Pedal to Control Change numbers 1 to 119, or to control the <i>USB Audio volume</i>. <b>Settings:</b> Off, 1–119, <i>USB Audio Volume</i> <b>Default:</b> Foot Pedal 1: 64 (Sustain) Foot Pedal 2: 11 (Expression)</p>
	Limit Low		<p>Determines the lowest value for the foot controller (FC7) connected to the FOOT PEDAL jack. <b>Settings:</b> 0–127 <b>Default:</b> 0</p>
	Limit High		<p>Determines the highest value for the foot controller (FC7) connected to the FOOT PEDAL jack. <b>Settings:</b> 0–127 <b>Default:</b> 127</p>
Receive SW	Expression	Part A	<p>Determines whether each Part receives (<i>On</i>) or ignores (<i>Off</i>) the corresponding MIDI messages received from external devices or the messages generated by operating the footswitch or foot controller. <b>Default:</b> <i>On</i></p>
	Sustain	Part B	
	Sostenuto	Part C	
	Soft		

## Function

Function name		Description
<i>Part Color</i>	<i>Part A</i>	Sets the LED color for the Part.
	<i>Part B</i>	<b>Settings:</b> <i>Red, Orange, Yellow, Lime, Green, Spring, Cyan, Azure, Blue, Violet, Magenta, Rose</i>
	<i>Part C</i>	
<i>Audio Trigger</i>	<i>Switch</i>	Switches the Audio Trigger function. <b>Default:</b> <i>Off</i>
	<i>File</i>	Selects the audio file to use with the Audio Trigger function.
	<i>Volume</i>	Sets the playback volume for the audio file. <b>Settings:</b> <i>0–127</i>
	<i>Key Assign</i>	Selects the key for starting playback of the audio file. <b>Settings:</b> <i>Lowest, Highest</i> <b>Default:</b> <i>Highest</i>
	<i>Play Mode</i>	Sets the playback mode for the audio file. <ul style="list-style-type: none"> <li>• <i>One Shot:</i> Plays back the audio file from the beginning every time the key is pressed.</li> <li>• <i>Play/Stop:</i> Starts or stops the playback of the audio file each time the key is pressed. The playback starts from the beginning of the file.</li> <li>• <i>Play/Pause:</i> Starts or pauses the playback of the audio file each time the key is pressed. The playback resumes from the paused place.</li> </ul> <b>Default:</b> <i>One Shot</i>

**External Keyboard** Determines how the Parts are played when the CK receives performance information (key-on, key-off) MIDI messages from an external MIDI device. You can set up the CK with an external keyboard like a two-manual organ, or set up only a specific Part to play from the external keyboard.

**NOTE**

For Parts that are played only from an external keyboard, the Split setting shown on the Top screen changes from  to .

- *Ext+Int:* Internal tone generator plays sounds with both key-on signals received from an external MIDI device and performance on the CK's keyboard.
  - *ExtOnly:* Internal tone generator plays sounds only for key-on signals received from an external MIDI device. No sound is played when the keyboard on the CK is played.
  - *Off:* Internal tone generator does not play sounds for key-on signals received from an external MIDI device. Sound is played only when the keyboard on the CK is played.
- Default:** *Ext+Int*

**Connection example (for setting up the piano for Part A on the CK61 to be played only on the MX88)**

Part A = *ExtOnly*, Part B = *Off*, Part C = *Off*

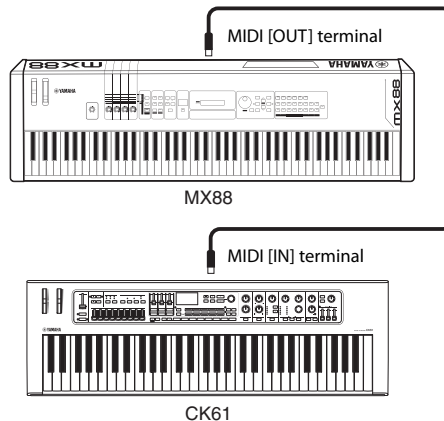

Function name	Description																	
Master Keyboard	This function is for using the CK as a master keyboard. It allows you to assign different areas of the keyboard to up to four zones, each of which can control a separate tone generator. For example, you can make a Live Set Sound combining Voices from both the CK and the connected external tone generators, or a Live Set Sound composed entirely with Voices of external tone generators.																	
<b>Example for combining the internal tone generator and Zones 1 to 3</b>																		
Mode SW	Switches the <i>Master Keyboard</i> mode. When <i>On</i> is selected, the <i>Master Keyboard</i> mode is enabled, and the indication <b>MST</b> appears on the Top screen. <b>Default:</b> <i>Off</i>																	
Advanced Zone SW	Changes the settings shown for <i>Master Keyboard</i> mode. When <i>On</i> is selected, the items with an asterisk (*) will be shown on the display. <b>Default:</b> <i>Off</i>																	
Zone Settings	Zone1 Zone2 Zone3 Zone4	<table border="1"> <tr> <td data-bbox="549 1189 671 1216">Zone Switch</td> <td data-bbox="710 1189 1425 1247">Determines whether to enable (<i>On</i>) or disable (<i>Off</i>) the zone. <b>Default:</b> Zone 1 = <i>On</i>, Zone 2–4 = <i>Off</i></td> </tr> <tr> <td data-bbox="549 1270 660 1296">Tx Channel</td> <td data-bbox="710 1270 1425 1359">Determines the MIDI transmit channel for the zone. <b>Settings:</b> 1–16 <b>Default:</b> Zone 1 = 1, Zone 2 = 2, Zone 3 = 3, Zone 4 = 4</td> </tr> <tr> <td data-bbox="549 1382 671 1408">Octave Shift</td> <td data-bbox="710 1382 1425 1471">Shifts the pitch of the zone in octaves. <b>Settings:</b> –3–+3 <b>Default:</b> +0</td> </tr> <tr> <td data-bbox="549 1494 651 1520">Transpose</td> <td data-bbox="710 1494 1425 1583">Changes the pitch of the zone in semitones. <b>Settings:</b> –11–+11 <b>Default:</b> +0</td> </tr> <tr> <td data-bbox="549 1606 655 1664">Note Limit Low</td> <td data-bbox="710 1606 1425 1664">Sets the lowest key in the zone. <b>Default:</b> C–2</td> </tr> <tr> <td data-bbox="549 1686 655 1744">Note Limit High</td> <td data-bbox="710 1686 1425 1744">Sets the highest key in the zone. <b>Default:</b> G8</td> </tr> <tr> <td data-bbox="549 1767 667 1794">Bank MSB *</td> <td data-bbox="710 1767 1425 1856">Determines the Bank Select MSB sent as a MIDI message to the external tone generator played by the zone. <b>Default:</b> 0</td> </tr> <tr> <td data-bbox="549 1879 660 1906">Bank LSB *</td> <td data-bbox="710 1879 1425 1968">Determines the Bank Select LSB sent as a MIDI message to the external tone generator played by the zone. <b>Default:</b> 0</td> </tr> </table>	Zone Switch	Determines whether to enable ( <i>On</i> ) or disable ( <i>Off</i> ) the zone. <b>Default:</b> Zone 1 = <i>On</i> , Zone 2–4 = <i>Off</i>	Tx Channel	Determines the MIDI transmit channel for the zone. <b>Settings:</b> 1–16 <b>Default:</b> Zone 1 = 1, Zone 2 = 2, Zone 3 = 3, Zone 4 = 4	Octave Shift	Shifts the pitch of the zone in octaves. <b>Settings:</b> –3–+3 <b>Default:</b> +0	Transpose	Changes the pitch of the zone in semitones. <b>Settings:</b> –11–+11 <b>Default:</b> +0	Note Limit Low	Sets the lowest key in the zone. <b>Default:</b> C–2	Note Limit High	Sets the highest key in the zone. <b>Default:</b> G8	Bank MSB *	Determines the Bank Select MSB sent as a MIDI message to the external tone generator played by the zone. <b>Default:</b> 0	Bank LSB *	Determines the Bank Select LSB sent as a MIDI message to the external tone generator played by the zone. <b>Default:</b> 0
Zone Switch	Determines whether to enable ( <i>On</i> ) or disable ( <i>Off</i> ) the zone. <b>Default:</b> Zone 1 = <i>On</i> , Zone 2–4 = <i>Off</i>																	
Tx Channel	Determines the MIDI transmit channel for the zone. <b>Settings:</b> 1–16 <b>Default:</b> Zone 1 = 1, Zone 2 = 2, Zone 3 = 3, Zone 4 = 4																	
Octave Shift	Shifts the pitch of the zone in octaves. <b>Settings:</b> –3–+3 <b>Default:</b> +0																	
Transpose	Changes the pitch of the zone in semitones. <b>Settings:</b> –11–+11 <b>Default:</b> +0																	
Note Limit Low	Sets the lowest key in the zone. <b>Default:</b> C–2																	
Note Limit High	Sets the highest key in the zone. <b>Default:</b> G8																	
Bank MSB *	Determines the Bank Select MSB sent as a MIDI message to the external tone generator played by the zone. <b>Default:</b> 0																	
Bank LSB *	Determines the Bank Select LSB sent as a MIDI message to the external tone generator played by the zone. <b>Default:</b> 0																	

Function name			Description
Master Keyboard	Zone Settings	Zone1 Zone2 Zone3 Zone4	<p><i>Program Change *</i> Determines the Program Change Number sent as a MIDI message to the external tone generator played by the zone. <b>Default:</b> 1</p> <hr/> <p><i>Volume *</i> Determines the volume sent as a MIDI message to the external tone generator played by the zone. <b>Default:</b> 100</p> <hr/> <p><i>Pan *</i> Determines the panning sent as a MIDI message to the external tone generator played by the zone. <b>Default:</b> C</p> <hr/> <p><i>Tx SW Note *</i> Determines whether to transmit (<i>On</i>) or not transmit (<i>Off</i>) MIDI note messages to the external tone generator played by the zone. <b>Default:</b> <i>On</i></p> <hr/> <p><i>Tx SW Bank *</i> Determines whether to transmit (<i>On</i>) or not transmit (<i>Off</i>) MIDI Bank Select messages to the external tone generator played by the zone. <b>Default:</b> <i>On</i></p> <hr/> <p><i>Tx SW Program *</i> Determines whether to transmit (<i>On</i>) or not transmit (<i>Off</i>) MIDI Program Change messages to the external tone generator played by the zone. <b>Default:</b> <i>On</i></p> <hr/> <p><i>Tx SW Volume *</i> Determines whether to transmit (<i>On</i>) or not transmit (<i>Off</i>) MIDI volume messages to the external tone generator played by the zone. <b>Default:</b> <i>On</i></p> <hr/> <p><i>Tx SW Pan *</i> Determines whether to transmit (<i>On</i>) or not transmit (<i>Off</i>) MIDI Pan messages to the external tone generator played by the zone. <b>Default:</b> <i>On</i></p> <hr/> <p><i>Tx SW PB *</i> Determines whether to transmit (<i>On</i>) or not transmit (<i>Off</i>) MIDI Pitch Bend messages to the external tone generator played by the zone. <b>Default:</b> <i>On</i></p> <hr/> <p><i>Tx SW Mod *</i> Determines whether to transmit (<i>On</i>) or not transmit (<i>Off</i>) MIDI Modulation messages to the external tone generator played by the zone. <b>Default:</b> <i>On</i></p> <hr/> <p><i>Tx SW Foot Pedal 1 *</i> Determines whether to transmit (<i>On</i>) or not transmit (<i>Off</i>) MIDI messages for FOOT PEDAL [1] to the external tone generator played by the zone. <b>Default:</b> <i>On</i></p> <hr/> <p><i>Tx SW Foot Pedal 2 *</i> Determines whether to transmit (<i>On</i>) or not transmit (<i>Off</i>) MIDI messages for FOOT PEDAL [2] to the external tone generator played by the zone. <b>Default:</b> <i>On</i></p>



## A/D Input

Function name		Description
<i>Volume</i>		Adjusts the volume of the audio signal input from the A/D INPUT jack for the Live Set Sound. <b>NOTE</b> Adjust the overall volume with the A/D INPUT [GAIN] knob. <b>Settings:</b> 0–127
<i>Input Effect 1</i> <i>Input Effect 2</i>	<i>Type</i>	Selects the type of Effect applied to the audio. <b>Settings:</b> <i>Thru</i> , Effect type (see “Effect list” on page 43) <b>Default:</b> <i>Thru</i>
	<i>Depth</i>	Adjusts the depth of the Effect applied to the audio. <b>Settings:</b> 0–127
	<i>Rate</i>	Adjusts the rate of Effect applied to the audio. <b>Settings:</b> 0–127
<i>Input EQ</i>		Sets the 3-band EQ for the audio.
	<i>High Gain</i>	Sets the signal level for the high band. <b>Settings:</b> –12 dB–0–+12 dB
	<i>High Frequency</i>	Sets the frequency for the high band. <b>Settings:</b> 500 Hz–16 kHz
	<i>Mid Gain</i>	Sets the signal level for the mid-band. <b>Settings:</b> –12dB–0–+12dB
	<i>Mid Frequency</i>	Sets the frequency for the mid-band. <b>Settings:</b> 100 Hz–10 kHz
	<i>Low Gain</i>	Sets the signal level for the low band. <b>Settings:</b> –12 dB–0–+12 dB
	<i>Low Frequency</i>	Sets the frequency for the low band. <b>Settings:</b> 32 Hz–2.0 kHz
<i>Noise Gate</i>	<i>Switch</i>	Turns the noise gate for the audio on/off. <b>Settings:</b> <i>Off, On</i> <b>Default:</b> <i>Off</i>
	<i>Threshold</i>	Sets the threshold for the noise gate for the audio. <b>Settings:</b> –73 dB––30 dB <b>Default:</b> –45 dB

## Name

Determines the name of a Live Set Sound. For details on editing Live Set Sound names, see Editing Live Set Sound names (page 26).

To store the edited Live Set Sound names, you’ll need to use the Store operation (page 10).

## Entire instrument (MENU button)

From the [MENU] button, you can configure various parameters and functions that affect the entire instrument. The changes made here will be stored in the CK.

### NOTICE

After the value has been changed, the setting will be saved when the operation goes back to the Top screen. Changes will not be saved if the CK has been turned off before the operation has gone back to the Top screen.

## Operation

1. Press the [MENU] button.

2. Use the VALUE buttons and Encoder dial to select an item, and then press the [ENTER] button.

### NOTE

You can also use the LIVE SET buttons [1] to [6] to select the item. The LIVE SET buttons [1] to [6] correspond to the items shown on the display in order from the top. The buttons light up when this feature is available.

3. Use the VALUE buttons and Encoder dial to change the value, and then press the [ENTER] button.

When the setting has been changed, the operation goes back to the previous screen for selecting the menu item.

## General

Function name	Description
System	<p><i>Master Tune</i></p> <p>Determines the tuning for the entire instrument.  <b>Settings:</b> 414.72 Hz–466.78 Hz  <b>Default:</b> 440.00 Hz</p>
	<p><i>Master EQ</i></p> <p>Sets the <i>Master EQ</i>.</p>
	<p><i>High Frequency</i></p> <p>Sets the frequency for the high band.  <b>Settings:</b> 500 Hz–16 kHz</p>
	<p><i>Mid Frequency</i></p> <p>Sets the frequency for the mid-band.  <b>Settings:</b> 100 Hz–10 kHz</p>
	<p><i>Low Frequency</i></p> <p>Sets the frequency for the low band.  <b>Settings:</b> 32 Hz–2.0 kHz</p>
Speaker	<p><i>Speaker EQ</i></p> <p>Selects the optimal sound quality of the built-in speakers for setting the CK on a keyboard stand where the bottom of the CK is open (<i>Normal</i>) or for setting on the table where the bottom of the CK is covered (<i>Table</i>).  <b>Settings:</b> <i>Normal, Table</i>  <b>Default:</b> <i>Normal</i></p>
	<p><i>Speaker Mute</i></p> <p>Selects to mute the built-in speakers automatically (<i>Auto</i>) or to mute the built-in speakers manually using the SPEAKERS switch (<i>Manual</i>) when the headphones are connected.  <b>Settings:</b> <i>Auto, Manual</i>  <b>Default:</b> <i>Auto</i></p>
	<p><i>Auto Power Off</i></p> <p>Switches the <i>Auto Power Off</i> function setting.</p> <ul style="list-style-type: none"> <li>• <i>Disable:</i> The CK is not automatically turned off.</li> <li>• <i>Enable:</i> The CK is turned off automatically after being inactive for 30 minutes.</li> <li>• <i>Auto:</i> The <i>Auto Power Off</i> function is disabled while the AC adaptor is being used, and enabled while batteries are being used.</li> </ul> <b>Default:</b> <i>Auto</i>
	<p><i>Power On Sound</i></p> <p>Selects which Live Set Sound is automatically called up when the CK is turned on.  <b>Default:</b> 1-1</p>

Function name			Description
MIDI	MIDI Port	MIDI	<p>Determines whether to use the MIDI terminals for transmitting or receiving MIDI messages with the internal tone generator.</p> <ul style="list-style-type: none"> <li>• <i>On</i>: Used as Port 1 (transmit or receive MIDI messages with the internal tone generator).</li> <li>• <i>Off</i>: Used as Port 2 (USB-MIDI interface). In this case, MIDI messages received by the MIDI [IN] terminal are sent to USB Port 2 (MIDI OUT 2). MIDI messages received by the USB Port 2 (MIDI IN 2) are sent to the MIDI [OUT] terminal.</li> </ul> <p><b>Default:</b> <i>On</i></p>
		USB	<p>Determines whether to use (<i>On</i>) the USB [TO HOST] terminal for transmission/reception of MIDI messages, or not (<i>Off</i>).</p> <p><b>Default:</b> <i>On</i></p>
MIDI Channel	Transmit		<p>Determines the MIDI transmit channel. When this is set to <i>Off</i>, MIDI messages are not transmitted.</p> <p><b>Settings:</b> 1–16, <i>Off</i></p> <p><b>Default:</b> 1</p>
	Receive		<p>Determines the MIDI receive channel. When this is set to <i>All</i>, MIDI messages will be received over all channels.</p> <p><b>Settings:</b> 1–16, <i>All</i></p> <p><b>Default:</b> 1</p>
MIDI Control			<p>Sets the MIDI control message to be sent out when using knobs and sliders on the front panel. For <i>MIDI Control</i>, the keyboard, Pitch Bend, Modulation, and pedals are excluded.</p> <ul style="list-style-type: none"> <li>• <i>On</i>: MIDI messages are transmitted when the corresponding controllers such as knobs and sliders are used, allowing you to use a DAW and external MIDI devices to receive and record the operation information.</li> <li>• <i>Off</i>: MIDI messages are not transmitted when the corresponding controllers are used.</li> </ul> <p><b>Default:</b> <i>Off</i></p> <p><b>NOTE</b></p> <ul style="list-style-type: none"> <li>• When MIDI messages corresponding to knobs and sliders are received from the DAW, the settings for those knobs and sliders are changed.</li> <li>• The MIDI message assignment for each knob or the slider is fixed. If you want to control the parameters in the DAW from the knobs and sliders on the CK, set up the computer to receive messages from the knobs and sliders. For details on MIDI messages, see page 54.</li> </ul>
Local Control			<p>Determines whether <i>Local Control</i> is on or off.</p> <p>When this is set to <i>Off</i>, the CK's tone generator is disconnected from the keyboard, and no sound will be produced when the keyboard is played. However, regardless of the setting here, performance information from the CK's keyboard is transmitted as MIDI messages, and the CK's tone generator will continue to produce sound in response to the MIDI messages received from MIDI input, depending on the MIDI settings.</p> <p><b>Default:</b> <i>On</i></p>
Controller Reset			<p>Determines whether to keep (<i>Hold</i>) or initialize (<i>Reset</i>) the values of controllers (such as Modulation wheel and Foot Controller) when switching to a different Live Set Sound. When this is set to <i>Reset</i>, the controllers are reset to the default as shown below when switching to a different Live Set Sound.</p> <ul style="list-style-type: none"> <li>• Pitch Bend: Center</li> <li>• Modulation: Minimum</li> <li>• Expression: Maximum</li> <li>• Pedal Wah: Minimum</li> </ul> <p><b>Default:</b> <i>Reset</i></p>

Function name			Description
MIDI	Advanced	Device Number	Determines the MIDI device number. The device number of the CK must match the device number of the external MIDI device when transmitting or receiving Bulk Dump, Parameter Changes, or other System Exclusive messages. <b>Settings:</b> 1–16, All, Off <b>Default:</b> All
		Control Delay	Adjusts the transmission timing for MIDI control messages transmitted when switching to a different Live Set Sound. Adjust the setting when the application on your computer does not receive messages correctly. <b>Settings:</b> 0–1500 msec <b>Default:</b> 0 msec
		Tx/Rx Pgm Change	Determines whether transmission/reception of Program Change messages between the CK and external MIDI devices is enabled ( <i>On</i> ) or disabled ( <i>Off</i> ). <b>Default:</b> On
		Tx/Rx Bank Select	Determines whether transmission/reception of Bank Select messages between the CK and external MIDI devices is enabled ( <i>On</i> ) or disabled ( <i>Off</i> ). <b>Default:</b> On
Audio	Output Gain		Adjusts the overall final output level of the CK. <b>Settings:</b> –24 dB–+0 dB–+24 dB <b>Default:</b> +0 dB
		A/D Input Type	Selects a line input ( <i>Line</i> ) or a dynamic mic ( <i>Mic</i> ) for use as the input source from the A/D INPUT jack. <b>Default:</b> Line
		USB Audio Volume	Determines the volume of the USB Audio input. <b>Settings:</b> 0–127 <b>Default:</b> 64
		USB Audio Loopback	Determines whether to mix the USB Audio input to the USB Audio Output ( <i>On</i> ) or not ( <i>Off</i> ). <b>Default:</b> Off
Control Panel	Panel Lock Settings	Live Set	Determines whether to enable ( <i>On</i> ) or disable ( <i>Off</i> ) the panel lock for each item. <b>Default:</b> On
		Organ	
		Filter/EG	
		Drive/Effect	
		Delay/Reverb	
		Equalizer	
	Display	Value Indication	Determines whether to show ( <i>On</i> ) or not show ( <i>Off</i> ) the values on the display (LCD) when the values for the controllers of each Part are changed. <b>Default:</b> On
		LCD Switch	Determines whether to show ( <i>On</i> ) or not show ( <i>Off</i> ) the Top screen on the display (LCD). The MENU and SETTINGS screens are always shown on the display regardless of the settings selected here. <b>Default:</b> On
		LCD Contrast	Adjusts the contrast of the Display (LCD). <b>Settings:</b> –10–+10 <b>Default:</b> +0

Function name		Description
Control Panel	Controller Mode	<p>Sets the conditions for a controller position to be reflected when the controllers' actual position and values called up with the LIVE SET [1] to [8] buttons do not match.</p> <ul style="list-style-type: none"> <li>• <i>Jump</i>: The position of a controller is reflected immediately when that controller is moved.</li> <li>• <i>Catch</i>: The current setting will be held until the controller's position matches (catches) values called up with the LIVE SET [1] to [8] buttons. Once the values have matched, the controller's position will be reflected.</li> </ul> <p><b>Default:</b> <i>Jump</i></p>
	Filter/EG Reset	<p>Determines whether to reset (<i>On</i>) or maintain without resetting (<i>Off</i>) the EG and FILTER parameters when a Voice for the Part has been changed.</p> <p><b>Default:</b> <i>On</i></p>
	Effect On/Off Reset	<p>Determines whether to reset (<i>On</i>) or maintain without resetting (<i>Off</i>) the Effect parameters when a Voice for the Part has been changed.</p> <p><b>Default:</b> <i>On</i></p>
Keyboard	Touch Curve	<p>Determines how actual velocities will be generated according to the strength with which you play notes on the keyboard.</p> <ul style="list-style-type: none"> <li>• <i>Normal</i>: This linear "curve" produces one-to-one correspondence between the strength of your keyboard playing (velocity) and the actual sound change.</li> <li>• <i>Soft</i>: This curve provides an increased response, especially for lower velocities.</li> <li>• <i>Hard</i>: This curve provides an overall decreased response, especially for higher velocities, meaning that greater strength is needed to produce louder sound.</li> <li>• <i>Wide</i>: This curve accentuates your playing strength by producing lower velocities in response to softer playing and louder velocities in response to harder playing. As such, you can use this setting to expand your dynamic range.</li> <li>• <i>Fixed</i>: This setting produces the same amount of sound change, no matter what your playing strength. The velocity of the notes you play is fixed at the value set here.</li> </ul> <p><b>Default:</b> <i>Normal</i></p>
	Fixed Velocity	<p>When <i>Touch Curve</i> above is set to <i>Fixed</i>, this lets you set the desired fixed velocity, letting you keep the same, regardless of how hard or soft you play the keyboard.</p> <p><b>Settings:</b> 1–127</p> <p><b>Default:</b> 64</p>
Foot Pedal	Pedal 1 Pedal 2	<p>Pedal Type</p> <p>Sets the type of pedal connected to the FOOT PEDAL [1] jack or the FOOT PEDAL [2] jack. Select <i>FC3A (HalfOn)</i> when using a Half Damper pedal.</p> <p><b>Settings:</b> <i>FC3A (HalfOn)</i>, <i>FC3A (HalfOff)</i>, <i>FC4A/FC5</i>, <i>FC7</i></p> <p><b>Default:</b> <i>Pedal 1: FC3A (HalfOn)</i> <i>Pedal 2: FC7</i></p>
	Live Set Inc/Dec	<p>Sets the type of operation for using the pedals connected to the FOOT PEDAL [1] jack or the FOOT PEDAL [2] jack.</p> <ul style="list-style-type: none"> <li>• <i>Off</i>: Operates the control change assigned to the Live Set Sound.</li> <li>• <i>Live Set Inc</i>: Selects the next Live Set Sound when operating the pedal.</li> <li>• <i>Live Set Dec</i>: Select the previous Live Set Sound when operating the pedal.</li> </ul> <p><b>Default:</b> <i>Off</i></p>

## Job

Function name		Description	
<i>Live Set Manager</i>	<i>Swap</i>	Swaps the currently selected Live Set Sound with another user-specified Live Set Sound.	
	<i>Copy</i>	Copies the currently selected Live Set Sound to another user-specified Live Set Sound.	
	<i>Initialize</i>	Resets all parameters of the currently selected Live Set Sound to their defaults.	
<i>Part/Effect Manager</i>	<i>Copy</i>	<i>Part A</i>	Copies the Part A settings of the Live Set Sound.
		<i>Part B</i>	Copies the Part B settings of the Live Set Sound.
		<i>Part C</i>	Copies the Part C settings of the Live Set Sound.
		<i>Delay</i>	Copies the Delay settings of the Live Set Sound.
		<i>Reverb</i>	Copies the Reverb settings of the Live Set Sound.
	<i>Paste</i>	<i>Part A</i>	Pastes the copied settings. The paste function cannot be used when nothing has been copied.
		<i>Part B</i>	
		<i>Part C</i>	
		<i>Delay</i>	
		<i>Reverb</i>	
	<i>Swap Part</i>	<i>Part A ↔ B</i>	Swaps the Part A settings and the Part B settings of the Live Set Sound.
		<i>Part B ↔ C</i>	Swaps the Part B settings and the Part C settings of the Live Set Sound.
		<i>Part C ↔ A</i>	Swaps the Part C settings and the Part A settings of the Live Set Sound.
	<i>Swap EFFECT 1/2</i>	<i>Part A</i>	Swaps the EFFECT 1 settings and the EFFECT 2 settings of a specified Part in the Live Set Sound.
		<i>Part B</i>	
<i>Part C</i>			
<i>Edit Recall</i>	<p>Recalls the last edited but not yet stored Live Set Sound settings. If, while editing a Live Set Sound, you select a different Live Set Sound and then return to the one currently being edited, the latest stored version will be called up instead of the current one. If this occurs, use this function to restore the Live Set Sound setting you are currently editing.</p> <p><b>NOTICE</b>  <b>The latest edited Live Set Sound will be lost when the CK is turned off.</b></p>		
<i>Menu Initialize</i>	Resets the settings of MENU screens to the default values.		
<i>Factory Reset</i>	Restores the CK including all Live Set Sounds to its factory default.		

## File

Function name		Description
<i>Back Up File</i>	<i>Save</i>	Saves all the Live Set settings and other settings for the entire instrument stored in the CK to a USB flash drive as a backup file (with the extension .Y1A).
	<i>Load (*)</i>	Loads the settings to the CK from a backup file saved on a USB flash drive.
<i>Live Set All File</i>	<i>Save</i>	Saves all the Live Set settings stored in the CK to a USB flash drive as a <i>Live Set All File</i> (with the extension .Y1L).
	<i>Load (*)</i>	Loads the settings to the CK from a <i>Live Set All File</i> saved on a USB flash drive.
<i>Live Set Page File</i>	<i>Save</i>	Saves the currently selected Live Set Page stored in the CK to a USB flash drive as a <i>Live Set Page File</i> (with the extension .Y1P).
	<i>Load (*)</i>	Loads the settings to the CK from a <i>Live Set Page File</i> saved on a USB flash drive.
<i>Live Set Sound File</i>	<i>Save</i>	Saves the currently selected Live Set Sound stored in the CK to a USB flash drive as a <i>Live Set Sound File</i> (with the extension .Y1S).
	<i>Load</i>	Loads the settings to the CK from a <i>Live Set Sound File</i> saved on a USB flash drive.
<i>File Utility</i>	<i>Rename</i>	Changes the name of a file in a USB flash drive.
	<i>Delete</i>	Deletes a file in a USB flash drive.
	<i>Format</i>	Formats (initializes) a USB flash drive. Formatting is required when using a new USB flash drive. <b>NOTICE</b> <b>When a USB flash drive is formatted, all of its content will be deleted. Make sure before formatting that the USB flash drive contains no irreplaceable data.</b>

\* You can load a single Live Set Sound you choose from a file containing multiple Live Set Sounds such as *Backup file*, *Live Set All file*, and *Live Set Page file*.

## Bluetooth

Function name	Description
<i>Switch</i>	Switches the <i>Bluetooth</i> function on/off. <b>Settings:</b> <i>Off, On</i> <b>Default:</b> <i>Off</i>
<i>Volume</i> <sup>*1</sup>	Adjusts the <i>Bluetooth</i> audio volume. <b>Settings:</b> 0–127 <b>Default:</b> 64
<i>Pairing</i> <sup>*1</sup>	Pairs with the <i>Bluetooth</i> -equipped device.

\*1 When the *Switch* is set to *Off*, *Volume* and *Pairing* will be hidden.

## Version Info

Shows the version of the CK's firmware.

## Shortcut operations

By using the buttons or knob, while holding down the [ENTER] button, you can use the shortcut operations to access the functions in the Live Set Sound SETTINGS.

Locations	Operations	Descriptions
Transpose & Octave	[ENTER] button + TRANSPOSE [-] button	Transposes the pitch of the keyboard up or down in semitones. This operation is the same as <i>Sound Transpose</i> .
	[ENTER] button + TRANSPOSE [+] button	<b>NOTE</b> The value is not transmitted as a MIDI message.
	TRANSPOSE buttons [-] + [+] (together)	<i>Keyboard Transpose</i> is set to "0."
	Part select button ([A]-[C]) + OCTAVE [-] button	Shifts the octave range of the specified Part up or down. This operation is the same as setting the Note Shift to "+12" or "-12." The Note Shift range is from -12 to +12.
	Part select button ([A]-[C]) + OCTAVE [+] button	<b>NOTE</b> The value is not transmitted as a MIDI message.
	OCTAVE buttons [-] + [+]	<i>Keyboard Octave</i> is set to "0."
Organ	[ENTER] button + VIBRATO/CHORUS [TYPE] button	Switches the Vibrato/Chorus type in reverse order. This is useful when you want to return to the previous type.
Live Set	Pressing two or three Part select buttons ([A]-[C]) at once	Selects multiple Parts at once. Useful for selecting the same settings for Filter, EG, and Insertion Effects.
	Holding down two of the Part select buttons ([A]-[C]) at once	Swaps the settings of the selected Parts. This operation is the same as [MENU] button → Job → Part/Effect Manager → Swap Part.
	[ENTER] button + [SETTINGS] button	Resets the Live Set Sound currently being edited to its default state. This operation does not overwrite the stored Live Set Sound. This operation is useful when you want to reset all values to start over. <b>NOTE</b> To reset both the Live Set Sound currently being edited as well as the stored Live Set Sound, use the [MENU] button → Job → Live Set Manager → Initialize (page 40).
	[ENTER] button + [MENU] button	Determines whether the panel lock function is enabled (On) or disabled (Off).
	[ENTER] button + MONO [TYPE] button	Opens the <i>Portamento Time</i> setting screen.
	[ENTER] button + UNISON [TYPE] button	Opens the <i>Unison Detune</i> setting screen.
	PAGE buttons [<] + [>]	Shows the Live Set View. To close the Live Set View, press the [EXIT] button.
Effect	[ENTER] button + EFFECT1-EFFECT2 select button	Swaps the settings of EFFECT 1 and EFFECT 2 in the selected Part. This operation is useful when you want to change the order in which the two Insertion Effects are applied. This operation is the same as the [MENU] button → Job → Part/Effect Manager → Swap EFFECT 1/2.
	[ENTER] button + Effect [TYPE] knob	Moves to the beginning of the next or previous category. This operation is useful when you want to quickly switch to the desired type. For more information on Insertion Effect Types, see the "Effect list" (page 43).

## When using Tempo Delay for DELAY

Operations	Descriptions
[ENTER] button	Use the [ENTER] button as a Tap button. Press the button at least three times to set the tempo.
[ENTER] button + DELAY [TIME] knob	Changes the <i>Tempo Delay Time</i> .



# Effect list

## ■ Effect diagram

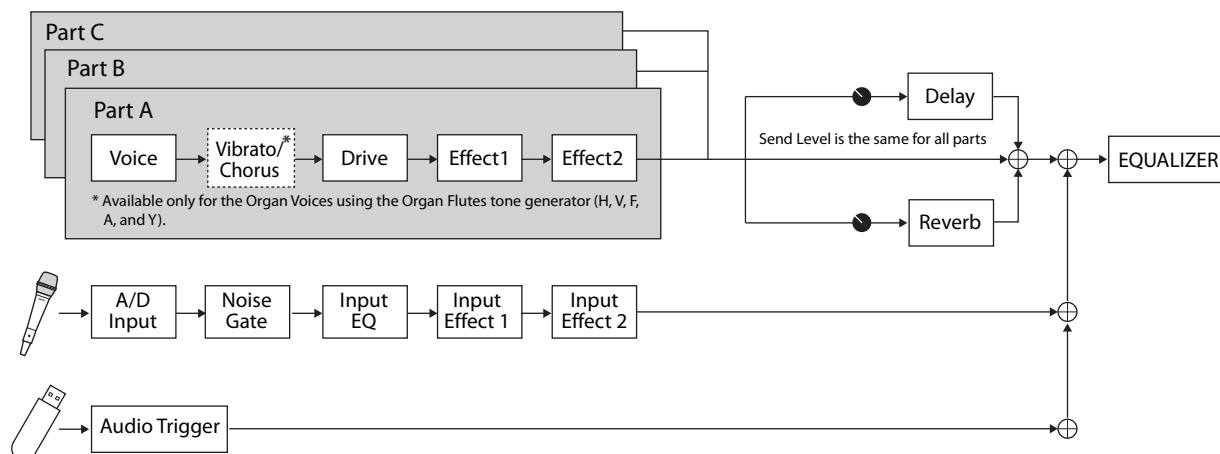

Category	Type	Description	Stereo/Mono
Chorus	G Chorus	Chorus effect that produces a deep sound with complex modulation. Turn the [DEPTH] knob to adjust the depth, and the [RATE] knob to adjust the speed.	Stereo
	SPX Chorus	Chorus effect that uses a three-phase LFO to create a richer and warmer sound, with a wider stereo spread. Turn the [DEPTH] knob to adjust the depth, and the [RATE] knob to adjust the speed.	Stereo
	Symphonic	Chorus effect that features multiple sound modulations to give a greater sense of spaciousness. Turn the [DEPTH] knob to adjust the depth, and the [RATE] knob to adjust the speed.	Stereo
	816 Chorus	Chorus effect that simulates the detuned FM chorus of the TX816. Turn the [DEPTH] knob to adjust the modulation depth, and the [RATE] knob to adjust the speed.	Stereo
Flanger	VCM Flanger	Vintage flanger effect featuring a warm analog sound. Turn the [DEPTH] knob to adjust the depth and feedback level, and the [RATE] knob to adjust the speed.	Stereo
	Cross FB Flanger	Vintage flanger effect featuring a complex sound by cross feedback. Turn the [DEPTH] knob to adjust the depth and feedback level, and the [RATE] knob to adjust the speed.	Stereo
Phaser	VCM Stereo Phaser	Vintage phaser effect featuring a warm analog sound. Turn the [DEPTH] knob to adjust the depth and feedback level, and the [RATE] knob to adjust the speed.	Stereo
	Small Phaser	Vintage phaser effect that features a smooth and unique sweeping effect. Turn the [DEPTH] knob to switch the modulation type—which differs depending on whether the knob is set to the left or the right—and turn the [RATE] knob to adjust the speed.	Mono
	Max90	Classic vintage phaser effect. Turn the [DEPTH] knob to switch the feedback level type—which differs depending on whether the knob is set to the left or the right—and turn the [RATE] knob to adjust the speed.	Mono
	Dual Phaser	Vintage phaser effect that features two phasers with different characteristics. Turn the [DEPTH] knob to adjust the speed of the phaser 1, and the [RATE] knob to adjust the speed of the phaser 2.	Mono
Trm/Rtr	Tremolo	A modulation effect that changes the volume cyclically. Turn the [DEPTH] knob to adjust the depth, and the [RATE] knob to adjust the speed.	Stereo
	Auto Pan	A modulation effect that moves the sound in the stereo field cyclically left and right. Turn the [DEPTH] knob to adjust the width for the stereo field, and the [RATE] knob to adjust the speed.	Stereo
	Simple Rotary	Simple rotary speaker effect. Turn the [DEPTH] knob to adjust the volume and distortion level, and the [RATE] knob to adjust the rotation speed.	Mono

Category	Type	Description	Stereo/ Mono
Dist	<i>British Combo</i>	Warm distortion effect (overdrive). Turn the [DEPTH] knob to adjust the distortion level, and the [RATE] knob to adjust the brilliance (brightness of the sound).	<i>Mono</i>
	<i>British Lead</i>	Hard rock type distortion effect. Turn the [DEPTH] knob to adjust the distortion level, and the [RATE] knob to adjust the treble (attack for the high band).	<i>Mono</i>
	<i>Small Stereo</i>	Stereo distortion effect. Turn the [DEPTH] knob to adjust the distortion level, and the [RATE] knob to adjust the presence (clearness of sound).	<i>Stereo</i>
Comp/EQ	<i>Compressor</i>	Stereo compressor. Turn the [DEPTH] knob to adjust the threshold, and the [RATE] knob to adjust the output volume.	<i>Stereo</i>
	<i>Tone Control</i>	Shelving equalizer. Use the [DEPTH] knob to adjust the low band, and the [RATE] knob to adjust the high band.	<i>Stereo</i>
	<i>1 Band EQ Narrow</i>	Peaking equalizer with narrow Q (bandwidth). Use the [DEPTH] knob to adjust the gain, and the [RATE] knob to adjust the center frequency.	<i>Stereo</i>
	<i>1 Band EQ Wide</i>	Peaking equalizer with wide Q (bandwidth). Use the [DEPTH] knob to adjust the gain, and the [RATE] knob to adjust the center frequency.	<i>Stereo</i>
Wah	<i>Auto Wah</i>	Wah modulation effect that changes cyclically. Turn the [DEPTH] knob to adjust the resonance level, and the [RATE] knob to adjust the speed.	<i>Stereo</i>
	<i>Touch Wah</i>	Wah effect that responds to volume changes by keyboard touch. Turn the [DEPTH] knob to adjust the sensitivity, and the [RATE] knob to adjust the resonance level.	<i>Stereo</i>
	<i>Pedal Wah</i>	Wah effect that is pedal-controlled. Turn the [DEPTH] knob to adjust the distortion level, and the [RATE] knob to adjust the resonance level. The <i>pedal wah</i> effect can be controlled with a pedal if <i>Foot Pedal Assign</i> is set to 4 (Pedal Wah).	<i>Stereo</i>
Delay	<i>Digital Delay</i>	Clean digital delay. Turn the [DEPTH] knob to adjust the depth and feedback level, and the [RATE] knob to adjust the delay time.	<i>Stereo</i>
	<i>Analog Delay</i>	Delay featuring a warm analog sound. Turn the [DEPTH] knob to adjust the feedback level, and the [RATE] knob to adjust the delay time.	<i>Stereo</i>
	<i>Cross Delay</i>	Delay that alternates between the left and right. Turn the [DEPTH] knob to adjust the depth and feedback level, and the [RATE] knob to adjust the delay time.	<i>Stereo</i>
Reverb	<i>Hall Reverb</i>	Simulates the reverberation of a hall. Turn the [DEPTH] knob to adjust the depth, and the [RATE] knob to adjust the reverb time (reverberation length).	<i>Stereo</i>
	<i>Room Reverb</i>	Simulates the reverberation of a room. Turn the [DEPTH] knob to adjust the depth, and the [RATE] knob to adjust the reverb time (reverberation length).	<i>Stereo</i>
	<i>Reverse Reverb</i>	The effect that simulates reverse playback Gated Reverb. Turn the [DEPTH] knob to adjust the depth, and the [RATE] knob to adjust the reverb time (reverberation length).	<i>Stereo</i>
Others	<i>Ring Modulator</i>	An effect that changes the sound in metallic and wildly distorting synth ways. Turn the [DEPTH] knob to adjust the depth, and the [RATE] knob to adjust the frequency.	<i>Stereo</i>
	<i>Slicer</i>	An effect that slices the input sound into rhythmically interrupted segments. Turn the [DEPTH] knob to adjust the gate time (length for the sliced note), and the [RATE] knob to adjust the fineness of slicing.	<i>Stereo</i>
	<i>LP Filter</i>	Filter that cuts sounds at frequencies higher than the cutoff frequency. Turn the [DEPTH] knob to adjust the cutoff frequency, and the [RATE] knob to adjust the resonance.	<i>Stereo</i>
	<i>HP Filter</i>	Filter that cuts sounds at frequencies lower than the cutoff frequency. Turn the [DEPTH] knob to adjust the cutoff frequency, and the [RATE] knob to adjust the resonance.	<i>Stereo</i>

Category	Type	Description	Stereo/ Mono
<i>Others</i>	<i>Lo-Fi</i>	An effect that re-samples and degrades the input sound. Turn the [DEPTH] knob to adjust the coarseness of the sound, and the [RATE] knob to adjust the sampling frequency. Turn each knob clockwise to make them sound more degraded and less clear.	<i>Mono</i>
	<i>Damper Resonance</i>	An effect that reproduces the sound produced by open strings of a piano while the damper pedal is pressed. Turn the [DEPTH] knob to adjust the depth, and the [RATE] knob to adjust the damper openness.	<i>Stereo</i>
	<i>Harmonic Enhancer</i>	An effect that adds harmonic overtones to the input sound to makes the sound stand out. Turn the [DEPTH] knob to adjust the cutoff frequency of the high-pass filter, and the [RATE] knob to adjust the effect level.	<i>Stereo</i>

## Using with External Devices

By connecting external devices, you can take advantage of various convenient and powerful features of the CK.

For example, you can:

- Play the CK along with the songs played on your smartphone or a portable music player.
- Use smart device apps to manage the Live Set Sounds, create videos, and post videos on social media.
- Play the CK using sounds on external sound modules or other synthesizers.
- Play the CK sounds from an external keyboard.

### Precautions when using the USB [TO HOST] terminal

When connecting the computer to the USB [TO HOST] terminal, make sure to observe the following points to avoid freezing the computer/instrument and corrupting or losing the edited settings in SETTINGS.

#### NOTICE

- Use an AB type USB cable of less than 3 meters. USB 3.0 cables cannot be used.
- Perform the following before turning the power to the instrument on/off or plugging/unplugging the USB cable to/from the USB [TO HOST] terminal.
  - Quit any open application software on the computer.
  - Make sure that MIDI data is not being transmitted from the instrument. (MIDI data is transmitted when the notes on the keyboard are played.)
- While the computer is connected to the instrument, you should wait for six seconds or more between these operations: (1) when turning the power of the instrument off then on again, or (2) when alternately connecting/disconnecting the USB cable.

If the computer or the instrument freezes, restart the application software or the computer OS or turn the power to the instrument off then on again.

## Using Smart Devices

There are two ways of connecting a smart device: wireless connection via Bluetooth Audio and wired connection using a USB cable.

For more information on smart device applications that you can use with the CK, refer to the following website.

<https://www.yamaha.com/kbdapps/>

#### NOTICE

Be sure to place your smart device on a stable surface to prevent it from falling over and being damaged.

#### NOTE

To eliminate the risk of interference due to noise by your smart device when used in combination with the CK, turn on the Airplane Mode and then turn on Wi-Fi.

## Connecting via Bluetooth audio

### ■ Bluetooth capability

Depending on the country in which you purchased the product, the CK may not have Bluetooth capability.

By using the Bluetooth audio function, you can connect a Bluetooth-equipped device such as a smartphone and portable audio player wirelessly to the CK and use the speakers on the CK to play back the audio from the Bluetooth device.

#### NOTE

- Bluetooth headphones or speakers cannot be connected.
- There is no Bluetooth MIDI capability on the CK.

### ■ Pairing with a Bluetooth-equipped device

“Pairing” means registering Bluetooth-equipped smart devices on the CK and establish mutual recognition for wireless communication between the two.

Once the device is paired with the CK, it is not necessary to pair the two again (unless you’ve disabled pairing.)

#### 1. Select the setting from the [MENU] button → *Bluetooth* → *Switch to On*.

The CK will be paired, and the “*Bluetooth pairing...*” message will appear on the display.

To cancel the pairing, press the [EXIT] button.

#### 2. Turn the Bluetooth setting ON on the Bluetooth-equipped device and select CK61 or CK88 from the list.

- Make sure to complete the settings on the smart device within a minute. After that, the pairing mode ends automatically.
- If you are required to enter a passkey, enter the numerals “0000.”

When the pairing is completed, the  (Bluetooth) mark appears on the top screen.

Use the Bluetooth-equipped device to adjust the volume of the sound input via Bluetooth. To adjust the volume balance between the sound input via

Bluetooth and your performance on the CK, you can also use the [MENU] button → *Bluetooth* → *Volume*.

### 3. Playback audio on the Bluetooth-equipped device to confirm that the built-in speakers or the headphones connected to the CK can output the audio sound.

When you turn on the CK the next time, the last connected smart device will be connected to the CK automatically if the Bluetooth function of the smart device and the CK are set to on. If it is not connected automatically, select the model name of the CK from the connection list on the smart device.

#### ■ Switching the Bluetooth off

Select the setting from the [MENU] button → *Bluetooth* → *Switch to Off*.

## Connecting using the USB [TO HOST] terminal

For more information on how to connect a device to the USB [TO HOST] terminal, refer to the “Smart Device Connection Manual.”

#### ■ Smart Device Connection Manual

Access the website below and then open “Manual Library.” Select your language, and then enter “smart device” in the “Model Name or Keyword” field and finally click “Search.”

<https://download.yamaha.com/>

For setting the sound input from the USB audio to output to the computer or smart device connected to the USB [TO HOST] jack of the CK, set from the [MENU] button → *General* → *Audio* → *USB Audio Loopback* (page 38).

## Connecting to a computer

By connecting the CK to your computer, you can expand your musical possibilities by using music production software or DAWs. Here are some of the creative options you can explore.

- Recording your performance to a DAW
- Playing the software synthesizer from the CK
- Playing the internal sound generator of the CK from a DAW

A USB cable and the Yamaha Steinberg USB Driver are necessary to connect the CK to the computer. Follow the instructions below to make the connection.

Before connecting the USB [TO HOST] terminal to a computer, be sure to read “Precautions when using the USB [TO HOST] terminal” on page 46.

### 1. Download the latest Yamaha Steinberg USB Driver from the URL below. <https://download.yamaha.com/>

#### NOTE

- For more information on the system requirements for the Yamaha Steinberg USB Driver, refer to the URL above.
- The Yamaha Steinberg USB Driver may be revised and updated without prior notice. For details and the latest information, refer to the URL above.

### 2. Install the Yamaha Steinberg USB Driver on your computer.

Refer to the Installation Guide included in the downloaded file.

### 3. Change the settings from the [MENU] button → *General* → *MIDI* → *MIDI Port* → *USB to On* to set the CK to send and receive MIDI through the USB [TO HOST] terminal.

## Controlling a synthesizer or tone generator module from the CK

You can play the sounds of an external MIDI tone generator by playing on the CK’s keyboard. By setting the [MENU] button → *General* → *MIDI* → *MIDI Control to On* (page 37), you can use the ORGAN FOOTAGE sliders and knobs for Filter and EG, for example, for controlling an external device.

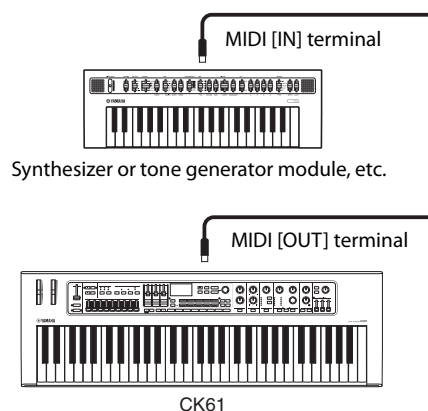

## Controlling the CK from an external keyboard

By combining with another keyboard, you can have the two connected instruments function like a two-manual organ. For example, if you wish to play both the CK and the other instrument by setting the [SETTINGS] button → *Function* → *External Keyboard* (page 32) to *Ext+Int*, or to play only the other instrument by setting to *ExtOnly*.

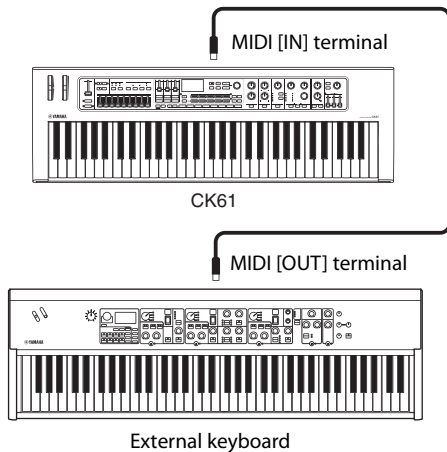

## Setting the MIDI transmit and receive channels

To control a device using MIDI, you must set the transmit channel on the controlling device and the receive channel on the controlled device to match. You can change the transmit channel (Tx) and receive channel (Rx) on the CK from the [MENU] button → *General* → *MIDI* → *MIDI Channel*.

### NOTE

For details on setting the transmit channel of an external MIDI keyboard or the receive channel of an external MIDI tone generator, refer to the owner's manual of that device.

## Disabling the internal tone generator sound when the built-in keyboard is played

If you want only the external tone generator connected to the MIDI [OUT] terminal or USB [TO HOST] terminal to produce sound when the keyboard of the CK is played, you can lower the CK's volume, or turn off all Parts, or set the value for *Local Control* under the [MENU] button → *General* → *MIDI* → *Local Control* to *Off* (page 37). The last method is especially convenient when recording with a DAW.

## Setting how the MIDI terminals are used (MIDI Port settings)

The CK provides two MIDI ports, each with different purposes.

- Port 1: For communication between the CK and a computer.
- Port 2: For communication between a computer and an external MIDI device by using the CK.

You can set whether to use the MIDI terminals as Port 1 or Port 2, from the [MENU] button → *General* → *MIDI* → *MIDI Port* → *MIDI* (page 37). Initially, it is set to Port 1.

### ■ Port 1

Use this Port to control the tone generator of the CK from an external device, or to control an external tone generator from the CK.

Set the value under the [MENU] button → *General* → *MIDI* → *MIDI Port* → *MIDI* to *On*.

### ■ Port 2

Use this port when you want to connect an external MIDI device to a computer via the CK.

Set the values under the [MENU] button → *General* → *MIDI* → *MIDI Port* as follows.

- MIDI: Off
- USB: On

### Example

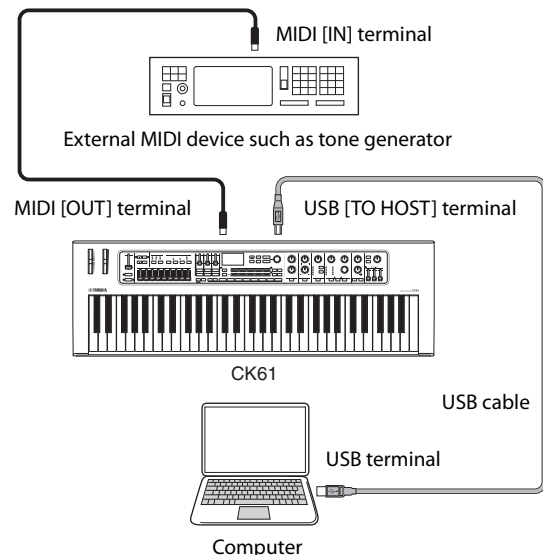

# Data List

## Live Set Sound List

### CK88

Page	No.	Name	Split Point	Part	Voice Name	MSB	LSB	PC
1	1	CFX Grand	G2	A	CFX Stereo	63	0	1
				B	–			
				C	–			
1	2	Mono U1	G2	A	U1	63	0	2
				B	–			
				C	–			
1	3	CF3 Pad	G2	A	Live CF3	63	0	3
				B	Back Pad			
				C	–			
1	4	Acoustic Split	G2	A	Acoustic Bass	63	0	4
				B	U1			
				C	H			
1	5	Panning Tines	G2	A	78Rd	63	0	5
				B	–			
				C	–			
1	6	Warm Reeds	G2	A	Wr Warm	63	0	6
				B	–			
				C	–			
1	7	Jazz Split	C3	A	H	63	0	7
				B	H			
				C	–			
1	8	Orchestra	G2	A	Orchestra 2	63	0	8
				B	Concert Str			
				C	Horn Section			
2	1	S700 Grand	G2	A	S700	63	1	1
				B	–			
				C	–			
2	2	Rock Piano	G2	A	Live CF3	63	1	2
				B	–			
				C	–			
2	3	80's Layer	G2	A	CFX St Bright	63	1	3
				B	73Rd Studio			
				C	–			
2	4	DX/Minilead	G2	A	DX 7 II	63	1	4
				B	Classic Mini			
				C	–			
2	5	78Rd Chorus	G2	A	78Rd	63	1	5
				B	–			
				C	–			
2	6	Funky Land Clav	G2	A	Clavi S	63	1	6
				B	–			
				C	–			
2	7	Rock Rotary	G2	A	H	63	1	7
				B	–			
				C	–			
2	8	Brass Section	G2	A	BrassSection5	63	1	8
				B	–			
				C	–			

Page	No.	Name	Split Point	Part	Voice Name	MSB	LSB	PC
3	1	CP80 Dirty Funk	G2	A	CP80 1	63	2	1
				B	–			
				C	–			
3	2	Phasing 73	G2	A	73Rd Studio	63	2	2
				B	–			
				C	–			
3	3	Fusion Layer	G2	A	73Rd Studio	63	2	3
				B	OB Brass 1			
				C	–			
3	4	EDM Pluck Split	G2	A	Synth Bass 2	63	2	4
				B	Popcorn			
				C	Sky Walk			
3	5	Amped Tines	G2	A	73Rd Studio	63	2	5
				B	–			
				C	–			
3	6	The Red Organ	G2	A	V	63	2	6
				B	–			
				C	–			
3	7	JP Strings	G2	A	JP Strings	63	2	7
				B	–			
				C	–			
3	8	Soft Synth Lead	G2	A	Wire Lead	63	2	8
				B	–			
				C	–			

## CK61

Page	No.	Name	Split Point	Part	Voice Name	MSB	LSB	PC
1	1	CFX Grand	G2	A	CFX Stereo	63	0	1
				B	—			
				C	—			
1	2	Panning Tines	G2	A	78Rd	63	0	2
				B	—			
				C	—			
1	3	Warm Reeds	G2	A	Wr Warm	63	0	3
				B	—			
				C	—			
1	4	80's Layer	G2	A	CFX St Bright	63	0	4
				B	73Rd Studio			
				C	—			
1	5	Funky Land Clav	G2	A	Clavi S	63	0	5
				B	—			
				C	—			
1	6	Brass Section	G2	A	BrassSection5	63	0	6
				B	—			
				C	—			
1	7	Jazz Split	C3	A	H	63	0	7
				B	H			
				C	—			
1	8	Soft Synth Lead	G2	A	Wire Lead	63	0	8
				B	—			
				C	—			
2	1	S700 Grand	G2	A	S700	63	1	1
				B	—			
				C	—			
2	2	78Rd Chorus	G2	A	78Rd	63	1	2
				B	—			
				C	—			
2	3	CP80 Dirty Funk	G2	A	CP80 1	63	1	3
				B	—			
				C	—			
2	4	CF3 Pad	G2	A	Live CF3	63	1	4
				B	Back Pad			
				C	—			
2	5	Amped Tines	G2	A	73Rd Studio	63	1	5
				B	—			
				C	—			
2	6	JP Strings	G2	A	JP Strings	63	1	6
				B	—			
				C	—			
2	7	Rock Rotary	G2	A	H	63	1	7
				B	—			
				C	—			
2	8	Orchestra	G2	A	Orchestra 2	63	1	8
				B	Concert Str			
				C	Horn Section			
3	1	Mono U1	G2	A	U1	63	2	1
				B	—			
				C	—			
3	2	Rock Piano	G2	A	Live CF3	63	2	2
				B	—			
				C	—			
3	3	Phasing 73	G2	A	73Rd Studio	63	2	3
				B	—			
				C	—			
3	4	DX/Minilead	G2	A	DX 7 II	63	2	4
				B	Classic Mini			
				C	—			
3	5	Acoustic Split	G2	A	Acoustic Bass	63	2	5
				B	U1			
				C	H			
3	6	Fusion Layer	G2	A	73Rd Studio	63	2	6
				B	OB Brass 1			
				C	—			
3	7	The Red Organ	G2	A	V	63	2	7
				B	—			
				C	—			
3	8	EDM Pluck Split	G2	A	Synth Bass 2	63	2	8
				B	Popcorn			
				C	Sky Walk			

## CK88 CK61

Page	No.	Name	Split Point	Part	Voice Name	MSB	LSB	PC
4	1	Live CF3 Grand	G2	A	Live CF3	63	3	1
				B	—			
				C	—			
4	2	Pretty Upright	G2	A	U1	63	3	2
				B	—			
				C	—			
4	3	Honky Dogs	G2	A	S700	63	3	3
				B	U1			
				C	—			
4	4	House Piano	G2	A	Digi Piano 2	63	3	4
				B	—			
				C	—			
4	5	Bubble Rds	C4	A	78Rd	63	3	5
				B	—			
				C	—			
4	6	Bright Reeds	G2	A	Wr Bright	63	3	6
				B	—			
				C	—			
4	7	Clavi S	G2	A	Clavi S	63	3	7
				B	—			
				C	—			
4	8	Trippy DX	G2	A	DX Legend	63	3	8
				B	—			
				C	—			
5	1	Comping Drawbar	G2	A	H	63	4	1
				B	—			
				C	—			
5	2	Jazz Swish	G2	A	H	63	4	2
				B	—			
				C	—			
5	3	Gospel Layers	G2	A	H	63	4	3
				B	H			
				C	—			
5	4	Lead Organ	G2	A	H	63	4	4
				B	—			
				C	—			
5	5	British Organ	G2	A	V	63	4	5
				B	—			
				C	—			
5	6	Aged Tone Organ	G2	A	A	63	4	6
				B	A			
				C	—			
5	7	Concert Organ	G2	A	Concert Organ	63	4	7
				B	Church Organ1			
				C	Church Organ1			
5	8	Big Pipes	G2	A	Organo Pleno	63	4	8
				B	Concert Organ			
				C	—			
6	1	Echo Guitar	G2	A	Nylon Guitar1	63	5	1
				B	—			
				C	—			
6	2	Acoustic Steel	G2	A	Steel Gt 2	63	5	2
				B	—			
				C	—			
6	3	Clean El-Gtr	G2	A	Clean Gt 1	63	5	3
				B	—			
				C	—			
6	4	Overdrive Gtr	G2	A	Clean Gt 3	63	5	4
				B	—			
				C	—			
6	5	Slap Bass	G2	A	Slap Bass	63	5	5
				B	—			
				C	—			
6	6	101 Bass	G2	A	Synth Bass 3	63	5	6
				B	Fundamental			
				C	—			
6	7	Mini Bass	G2	A	Unison Bass	63	5	7
				B	—			
				C	—			
6	8	Click Syn Bass	G2	A	Click SynBass	63	5	8
				B	—			
				C	—			



Page	No.	Name	Split Point	Part	Voice Name	MSB	LSB	PC
7	1	Quartet Strings	G2	A	Quartet	63	6	1
				B	–			
				C	–			
7	2	Ancient Sampler	G2	A	Tron Strings	63	6	2
				B	–			
				C	–			
7	3	On top	G2	A	Orchestra 1	63	6	3
				B	Oboe			
				C	French Horn			
7	4	2310 Orchestra	G2	A	Alto Flute	63	6	4
				B	Orchestra 2			
				C	Section Str 2			
7	5	Party Brass	G2	A	BrassSection2	63	6	5
				B	Forte Brass			
				C	BrassSection3			
7	6	Sax Section	G2	A	Sax Section 2	63	6	6
				B	–			
				C	–			
7	7	Flute	G2	A	Flute 1	63	6	7
				B	–			
				C	–			
7	8	Epic Calliope	G2	A	Calliope Ld 1	63	6	8
				B	–			
				C	–			
8	1	Comp and Solo	G2	A	73Rd Studio	63	7	1
				B	Dynmic Mini			
				C	–			
8	2	Nu Saw Lead	C3	A	–	63	7	2
				B	Saw Lead 1			
				C	–			
8	3	Arena Lead	G2	A	Dancy Hook	63	7	3
				B	–			
				C	–			
8	4	Vx Based PolyLd	C4	A	–	63	7	4
				B	–			
				C	V			
8	5	Analog Pad	G2	A	Soft Pad 2	63	7	5
				B	–			
				C	–			
8	6	Zen Pad	C4	A	Atmosphere	63	7	6
				B	ZEN			
				C	–			
8	7	Magic Bells Pad	G2	A	Bell Pad 1	63	7	7
				B	Slow Choir			
				C	Glocken 1			
8	8	Slow Choir	G2	A	Slow Choir	63	7	8
				B	–			
				C	–			
9	1	OB Brass	G2	A	OB Brass 1	63	8	1
				B	–			
				C	–			
9	2	Synth F.Horns	G2	A	Analog Brass1	63	8	2
				B	–			
				C	–			
9	3	Jumping Synths	G2	A	Jump Brass	63	8	3
				B	–			
				C	–			
9	4	Synth Strings	G2	A	Analog Str	63	8	4
				B	Syn Strings 1			
				C	–			
9	5	Warm Analog Str	G2	A	Lite Strings2	63	8	5
				B	Back Pad			
				C	–			
9	6	Mallet Lead	G2	A	Marimba 1	63	8	6
				B	–			
				C	–			
9	7	Dream Vibes	G2	A	Vibraphone	63	8	7
				B	–			
				C	–			
9	8	Enchantment	G2	A	Glocken 1	63	8	8
				B	–			
				C	–			

Page	No.	Name	Split Point	Part	Voice Name	MSB	LSB	PC
10	1	Sweet Piano	G2	A	S700	63	9	1
				B	Warm Strings			
				C	–			
10	2	BrghtPianoLayer	G2	A	CFX Stereo	63	9	2
				B	CP80 1			
				C	DX Woody			
10	3	80's CP Brassy	G2	A	CP80 1	63	9	3
				B	Synth Brass 2			
				C	–			
10	4	Gtr Pad Strings	G2	A	Classic Gt	63	9	4
				B	Soft Pad 2			
				C	Warm Strings			
10	5	Slow Piano Pad	G2	A	Live CF3	63	9	5
				B	V			
				C	Ring Pad			
10	6	Cinematic	G2	A	High Brass	63	9	6
				B	Orchestra 1			
				C	–			
10	7	Ambient Piano	G2	A	CFX St Warm	63	9	7
				B	CFX St Warm			
				C	Balimba			
10	8	Tricky Piano	G2	A	CFX Stereo	63	9	8
				B	–			
				C	–			

# Voice List

Category	Sub Category	No	Name	Parameter Value
Piano	Grand	1	CFX Stereo	0
		2	CFX St Bright	1
		3	CFX St Warm	2
		4	CFX Mono	3
		5	CFX Mn Bright	4
		6	CFX Mn Warm	5
		7	S700	6
		8	Live CF3	7
		9	Digi Piano 1	8
		10	Digi Piano 2	9
	Upright	11	U1	10
	CP	12	CP80 1	11
	13	CP80 2	12	
E.Piano	Rd	1	78Rd	13
		2	73Rd Studio	14
	Wr	3	Wr Warm	15
		4	Wr Bright	16
	Clavi	5	Clavi B	17
		6	Clavi S	18
		7	Harpsi 1	19
		8	Harpsi 2	20
	FM	9	DX Legend	21
		10	DX Woody	22
		11	DX FTine	23
		12	DX 7 II	24
		13	DX Mellow	25
		14	DX Crisp	26
Organ	Tone Wheel	1	H	27
	Combo	2	V	28
		3	F	29
		4	A	30
		5	Y	31
		Pipe	6	Pipe Organ 1
	7		Pipe Organ 2	33
	8		Concert Organ	34
	9		Grand Jeu	35
	10		FondsEtAnches	36
	11		Organo Pleno	37
	12		Diapason	38
	13		Claribel&Flut	39
	14		Soft Reeds	40
	15		Church Organ1	41
	16		Church Organ2	42
	17		Church Organ3	43
	18		Church Organ4	44
	Accordion	19	Accordion	45
	20	Musette	46	
Brs/Wind (Brass/Woodwind)	Ensemble	1	BrassSection1	47
		2	BrassSection2	48
		3	BrassSection3	49
		4	BrassSection4	50
		5	BrassSection5	51
		6	Sfz Brass	52
		7	Forte Brass	53
		8	SforzandoFall	54
		9	High Brass	55
		10	Mellow Brass1	56
		11	Mellow Brass2	57
		12	Soft Brass	58
		13	Tp&Tb Section	59
		14	Trb. Section	60
		15	Horn Section	61
		16	Horn Strings	62
		17	Brass Strings	63

Category	Sub Category	No	Name	Parameter Value		
Brs/Wind (Brass/Woodwind)	Solo	18	Sweet Trumpet	64		
		19	Trumpet	65		
		20	Trombone	66		
		21	French Horn	67		
		22	Horn	68		
		Saxophone	23	Sax Section 1	69	
			24	Sax Section 2	70	
			25	Sax Section 3	71	
			26	Sweet Alto	72	
			27	Alto Sax	73	
			28	Tenor Sax 1	74	
			29	Tenor Sax 2	75	
			30	Soprano Sax	76	
			31	Baritone Sax	77	
			Woodwind	32	Oboe	78
				33	Bassoon	79
				34	Clarinet	80
				35	Flute 1	81
				36	Flute 2	82
				37	Alto Flute	83
		38		Tape Flute	84	
		39		Recorder	85	
	40	Pan Flute 1		86		
	41	Pan Flute 2		87		
	42	Bottle		88		
	43	Shakuhachi		89		
	44	Ocarina		90		
	45	Harmonica 1		91		
	46	Harmonica 2		92		
	47	Bagpipe	93			
	Synth	48	Synth Brass 1	94		
		49	Synth Brass 2	95		
		50	Synth Brass 3	96		
		51	Synth Brass 4	97		
		52	Jump Brass	98		
		53	OB Brass 1	99		
		54	OB Brass 2	100		
		55	OB Brass 3	101		
		56	OB Brass 4	102		
		57	OB Brass 5	103		
		58	SoftSynBrs 1	104		
		59	SoftSynBrs 2	105		
		60	Big Squish	106		
		61	Analog Brass1	107		
		62	Analog Brass2	108		
	Gtr/Bass (Guitar/Bass)	Guitar	1	Classic Gt	109	
			2	Nylon Guitar1	110	
			3	Nylon Gt Harm	111	
			4	Nylon Guitar2	112	
			5	Steel Gt 1	113	
			6	Steel Gt 2	114	
			7	Steel Gt 3	115	
			8	12 Str Gt 1	116	
			9	12 Str Gt 2	117	
			10	Clean Gt 1	118	
			11	Clean Gt 2	119	
			12	Clean Gt 3	120	
			13	60's Clean Gt	121	
			14	Funk Guitar	122	
			15	12 Str Clean	123	
			16	Dist Guitar 1	124	
			17	Dist Guitar 2	125	
18			Over The Top	126		
19			Crunch Guitar	127		
20			Crunch Oct	128		
21			Mute Dist	129		
22			Jazz Guitar	130		
23			Hawaiian Gt	131		

Category	Sub Category	No	Name	Parameter Value	
Gtr/Bass (Guitar/Bass)	Bass	24	Acoustic Bass	132	
		25	Upright Bass	133	
		26	Finger Bass 1	134	
		27	Finger Bass 2	135	
		28	Finger Bass 3	136	
		29	Finger Bass 4	137	
		30	Pick Bass 10M	138	
		31	Pick Bass 1 M	139	
		32	Pick Bass 1 O	140	
		33	Pick Bass 2	141	
		34	Slap Bass	142	
		35	Fretless Ba 1	143	
		36	Fretless Ba 2	144	
		Bass +Drum	37	A.Bass + Cym	145
			38	E.Bass + Cym	146
		Synth	39	Synth Bass 1	147
			40	Synth Bass 2	148
			41	Synth Bass 3	149
			42	Synth Bass 4	150
			43	Synth Bass 5	151
			44	Big Bass	152
			45	101 Bass	153
			46	Competitor	154
			47	Perc Punch	155
			48	Trance Bass	156
			49	Dark Bass	157
			50	Click SynBass	158
			51	Acid Bass	159
			52	Square Bass	160
			53	Long Spit	161
			54	Fundamental	162
			55	One Voice	163
	56		Fat Sine	164	
	57		Fat Sine Res	165	
	58		Unison Bass	166	
	Strings	Ensemble	1	Section Str 1	167
			2	Section Str 2	168
			3	Section Str 3	169
			4	Strings 1	170
			5	Strings 2	171
			6	Orchestra 1	172
			7	Orchestra 2	173
			8	Arco String	174
			9	Fast Strings	175
			10	Marcato Str	176
			11	Concert Str	177
			12	Legato Str	178
			13	Warm Strings	179
			14	Slow Str 1	180
			15	Slow Str 2	181
			16	Slow Str 3	182
			17	60's Strings	183
			18	70's Strings1	184
			19	70's Strings2	185
			20	SlwAtkTremolo	186
			21	Tremolo Str	187
			22	Velo Strings	188
			23	Quartet	189
24			Tron Strings	190	
25			Tape Strings	191	
26			Flute Strings	192	
Solo		27	Sweet Violin	193	
		28	Violin	194	
		29	Cello	195	
Pizzicato		30	Pizzicato 1	196	
		31	Pizzicato 2	197	
		32	Harp	198	

Category	Sub Category	No	Name	Parameter Value		
Strings	Synth	33	Syn Strings 1	199		
		34	Syn Strings 2	200		
		35	Syn Strings 3	201		
		36	Analog Str	202		
		37	Lite Strings1	203		
		38	Lite Strings2	204		
		39	JP Strings	205		
		40	Pop Syn Str	206		
		41	Unison Str	207		
		42	Oct Syn Str	208		
		Pad	Pad	1	Bell Pad 1	209
				2	Bell Pad 2	210
				3	BrightPadBell	211
				4	Sharp Teeth	212
5	Ring Pad			213		
6	Anlg Rez Pad			214		
7	LFO Pad			215		
8	Chill Scap			216		
9	Strings Pad			217		
10	Back Pad			218		
11	Planet			219		
12	Atmosphere			220		
13	Click Pad			221		
14	Pad 80			222		
15	Poly Pad			223		
16	Glass Harp			224		
17	Digi Stuff			225		
18	New Age Pad			226		
19	Darklight			227		
20	Neo Crystal			228		
21	Vapor			229		
22	Soft Pad 1			230		
23	Soft Pad 2			231		
24	VP Soft			232		
25	Glass Pad			233		
26	Sine Pad			234		
27	Echoes			235		
28	Ambient Pad			236		
29	Pan Pad			237		
30	Sci-Fi			238		
31	Big Pan			239		
32	Goblins			240		
33	Sweep Pad 1			241		
34	Sweep Pad 2			242		
35	Nowhere			243		
36	Goblins Synth			244		
37	Celestial			245		
38	Converge			246		
39	Creation			247		
40	Ancestral			248		
41	Soundtrack	249				
42	Echo Pad	250				
43	Rain	251				
44	Analog Pad	252				
45	Dark Light	253				
46	Digi Pad	254				
47	Noble Pad	255				
48	Pop Pad	256				
49	Fat Saw	257				
50	Angel Pad	258				

Category	Sub Category	No	Name	Parameter Value	
Pad	Choir	51	Choir 1	259	
		52	Choir 2	260	
		53	Choir 3	261	
		54	Air Choir	262	
		55	Choir Aah	263	
		56	Voice Oohs	264	
		57	Slow Vox	265	
		58	Slow Choir	266	
		59	Itopia	267	
		60	Mystic Pad	268	
		Sound FX	61	Twist	269
			62	Da Pad	270
			63	Dark Star	271
			64	Mind Bell	272
	65		ZEN	273	
	Lead		Analog	1	Dancy Hook
		2		Faat Dance	275
		3		Techno Brass	276
		4		After 1984	277
		5		Analog Lead 1	278
		6		Analog Lead 2	279
		7		Analog Lead 3	280
		8		Analog Lead 4	281
		9		Saw Lead 1	282
		10		Saw Lead 2	283
		11		Saw Lead 3	284
12		Wire Lead		285	
13		Classic Mini		286	
14		Big Lead 1		287	
15		Big Lead 2		288	
16		Early Lead		289	
17		Troy		290	
18		Sync Saw Lead		291	
19		Punch Lead		292	
20		Soft RnB		293	
21		Popcorn		294	
22		Synth Trumpet		295	
23		Dynmic Mini		296	
24		Crying		297	
25		Funky Mini		298	
26		Funky Poly		299	
27		Mini Three		300	
28		Nu Mini		301	
29		Sky Walk		302	
30		Mini Soft		303	
31		Mini Lead		304	
32		Inda Night		305	
33		Sine Lead		306	
34		Tiny Lead		307	
35		Synth Whistle		308	
36		Raplead		309	
37		Funk Lead 1		310	
38		Funk Lead 2		311	
39		Rezz Punch		312	
40		Square Lead 1		313	
41	Square Lead 2	314			
42	Square Lead 3	315			
43	Soft Square	316			
44	5th Lead	317			
Digital	45	Digital Lead	318		
	46	Voice Lead	319		
	47	Wind Lead	320		
	48	Calliope Ld 1	321		
	49	Calliope Ld 2	322		
	50	Orchestra Hit	323		
	51	Impact	324		

Category	Sub Category	No	Name	Parameter Value
Chr.Perc. (Chromatic Percussion)	Mallet	1	Marimba 1	325
		2	Marimba 2	326
		3	Xylophone 1	327
		4	Xylophone 2	328
		5	Balimba	329
		6	Vib ST	330
		7	Vibraphone	331
		8	Hard Vibes	332
		9	Glocken 1	333
		10	Glocken 2	334
		11	Music Box	335
	Bell	12	Soft Crystal	336
		13	Tinkle Bell	337
		14	Tubular Bell	338
		15	Carillon	339
		Synth Bell	16	Digi Bell 1
	17		Digi Bell 2	341
	18		Digi Bell 3	342
	19		Nice Bell	343
	20		Stack Bell	344
	21		Bell Harp	345
	22		Harp Vox	346
	23		Round Glock	347
	24		Air Bells	348
	25		Star Dust	349
	26		Heaven Bell	350
Others	Ethnic	1	Kalimba	351
		2	Kanoon	352
		3	Shamisen	353
		4	Sitar 1	354
		5	Sitar 2	355
		6	Banjo	356
		7	Mandolin	357
		8	Dulcimer	358
		9	Koto	359
	Percussion	10	Timpani	360
		11	Steel Drums	361
		12	Agogo	362

# Control Change Number

\* CC numbers A, B, and C correspond to each of Part A, B, and C.

The parameters shown in parenthesis will not affect the internal tone generator.

For parameter values, see tables A to C on the next page.

	CC No.			Display	Controllers	Table
	A	B	C			
Rotary	9				4 ROTARY [STOP] button	C
	9				5 ROTARY [SPEED] button	C
Organ	18	77	111		10 ORGAN FOOTAGE slider [16']	D
	19	78	112		10 ORGAN FOOTAGE slider [5 1/3']	D
	20	79	113		10 ORGAN FOOTAGE slider [8']	D
	21	80	114		10 ORGAN FOOTAGE slider [4']	D
	22	81	115		10 ORGAN FOOTAGE slider [2 2/3']	D
	23	82	116		10 ORGAN FOOTAGE slider [2']	D
	24	83	117		10 ORGAN FOOTAGE slider [1 3/5']	D
	25	85	118		10 ORGAN FOOTAGE slider [1 1/3']	D
	26	86	119		10 ORGAN FOOTAGE slider [1']	D
	Volume	12			Volume	11 Part Volume slider [A]
27			11 Part Volume slider [B]	A		
87			11 Part Volume slider [C]	A		
Filter	74	30	104	Cutoff	29 FILTER [CUTOFF] knob	A
	71	31	105	Resonance	29 FILTER [RESONANCE] knob	A
EG	73	28	102	Attack	30 EG [ATTACK] knob	A
	72	29	103	Release	30 EG [RELEASE] knob	A
Drive	13	68	106	Depth	31 DRIVE [DEPTH] knob	A
Effect1	14	69	107	Depth	32 EFFECT [DEPTH] knob	A
	15	70	108	Rate	32 EFFECT [RATE] knob	A
Effect2	16	75	109	Depth	32 EFFECT [DEPTH] knob	A
	17	76	110	Rate	32 EFFECT [RATE] knob	A
Delay	93			Depth	33 DELAY [DEPTH] knob	A
	92			Time	33 DELAY [TIME] knob	A
Reverb	91			Depth	34 REVERB DEPTH knob	A
Equalizer	90			Equalizer Gain	35 EQUALIZER slider [LOW]	B
	89				35 EQUALIZER slider [MID]	B
	88				35 EQUALIZER slider [HIGH]	B

	CC No.	Display*	Controllers	Table
Foot Pedal 1, Foot Pedal 2, Modulation Wheel	1	Modulation		
	4	Pedal Wah		
	5	(Portamento Time)		
	6	(Data Entry MSB)		
	7	All Volume		
	9	Rotary Slow/Fast	4 ROTARY [STOP] button	C
			5 ROTARY [SPEED] button	C
	10	(Pan)		
	11	Expression		
	12	A: Volume	11 Part Volume slider [A]	A
	13	A: Drive Depth	31 DRIVE [DEPTH] knob	A
	14	A: Effect1 Depth	32 EFFECT [DEPTH] knob	A
	15	A: Effect1 Rate	32 EFFECT [RATE] knob	A
	16	A: Effect2 Depth	32 EFFECT [DEPTH] knob	A
	17	A: Effect2 Rate	32 EFFECT [RATE] knob	A
	18	A: Drawbar 16'	10 ORGAN FOOTAGE slider [16']	A
	19	A: Drawbar 5 1/3'	10 ORGAN FOOTAGE slider [5 1/3']	A
	20	A: Drawbar 8'	10 ORGAN FOOTAGE slider [8']	A
	21	A: Drawbar 4'	10 ORGAN FOOTAGE slider [4']	A
	22	A: Drawbar 2 2/3'	10 ORGAN FOOTAGE slider [2 2/3']	A
	23	A: Drawbar 2'	10 ORGAN FOOTAGE slider [2']	A
	24	A: Drawbar 1 3/5'	10 ORGAN FOOTAGE slider [1 3/5']	A
	25	A: Drawbar 1 1/3'	10 ORGAN FOOTAGE slider [1 1/3']	A
	26	A: Drawbar 1'	10 ORGAN FOOTAGE slider [1']	A

	CC No.	Display*	Controllers	Table
Foot Pedal 1, Foot Pedal 2, Modulation Wheel	27	B: Volume	11 Part Volume slider [B]	A
	28	B: Attack	30 EG [ATTACK] knob	A
	29	B: Release	30 EG [RELEASE] knob	A
	30	B: Cutoff	29 FILTER [CUTOFF] knob	A
	31	B: Resonance	29 FILTER [RESONANCE] knob	A
	32	(Bank LSB)		
	38	(Data Entry LSB)		
	64	Sustain		
	65	(Portamento)		
	66	Sostenuto		
	67	Soft		
	68	B: Drive Depth	31 DRIVE [DEPTH] knob	A
	69	B: Effect1 Depth	32 EFFECT [DEPTH] knob	A
	70	B: Effect1 Rate	32 EFFECT [RATE] knob	A
	71	A: Resonance	29 FILTER [RESONANCE] knob	A
	72	A: Release	30 EG [RELEASE] knob	A
	73	A: Attack	30 EG [ATTACK] knob	A
	74	A: Cutoff	29 FILTER [CUTOFF] knob	A
	75	B: Effect2 Depth	32 EFFECT [DEPTH] knob	A
	76	B: Effect2 Rate	32 EFFECT [RATE] knob	A
	77	B: Drawbar 16'	10 ORGAN FOOTAGE slider [16']	A
	78	B: Drawbar 5 1/3'	10 ORGAN FOOTAGE slider [5 1/3']	A
	79	B: Drawbar 8'	10 ORGAN FOOTAGE slider [8']	A
	80	B: Drawbar 4'	10 ORGAN FOOTAGE slider [4']	A
	81	B: Drawbar 2 2/3'	10 ORGAN FOOTAGE slider [2 2/3']	A
	82	B: Drawbar 2'	10 ORGAN FOOTAGE slider [2']	A
	83	B: Drawbar 1 3/5'	10 ORGAN FOOTAGE slider [1 3/5']	A
	84	(Portamento Ctrl)		
	85	B: Drawbar 1 1/3'	10 ORGAN FOOTAGE slider [1 1/3']	A
	86	B: Drawbar 1'	10 ORGAN FOOTAGE slider [1']	A
	87	C: Volume	11 Part Volume slider [C]	A
	88	Equalizer High	35 EQUALIZER slider [LOW]	B
	89	Equalizer Mid	35 EQUALIZER slider [MID]	B
	90	Equalizer Low	35 EQUALIZER slider [HIGH]	B
	91	Reverb Depth	34 REVERB DEPTH knob	A
	92	Delay Time	33 DELAY [DEPTH] knob	A
	93	Delay Depth	33 DELAY [TIME] knob	A
	95	(Effect5 Depth)		
	96	(Data Increment)		
	97	(Data Decrement)		
	98	(NRPN LSB)		
	99	(NRPN MSB)		
	100	(RPN LSB)		
	101	(RPN MSB)		
	102	C: Attack	30 EG [ATTACK] knob	A
	103	C: Release	30 EG [RELEASE] knob	A
	104	C: Cutoff	29 FILTER [CUTOFF] knob	A
	105	C: Resonance	29 FILTER [RESONANCE] knob	A
	106	C: Drive Depth	31 DRIVE [DEPTH] knob	A
	107	C: Effect1 Depth	32 EFFECT [DEPTH] knob	A
	108	C: Effect1 Rate	32 EFFECT [RATE] knob	A
	109	C: Effect2 Depth	32 EFFECT [DEPTH] knob	A
	110	C: Effect2 Rate	32 EFFECT [RATE] knob	A
	111	C: Drawbar 16'	10 ORGAN FOOTAGE slider [16']	A
	112	C: Drawbar 5 1/3'	10 ORGAN FOOTAGE slider [5 1/3']	A
	113	C: Drawbar 8'	10 ORGAN FOOTAGE slider [8']	A
	114	C: Drawbar 4'	10 ORGAN FOOTAGE slider [4']	A
	115	C: Drawbar 2 2/3'	10 ORGAN FOOTAGE slider [2 2/3']	A
	116	C: Drawbar 2'	10 ORGAN FOOTAGE slider [2']	A
	117	C: Drawbar 1 3/5'	10 ORGAN FOOTAGE slider [1 3/5']	A
	118	C: Drawbar 1 1/3'	10 ORGAN FOOTAGE slider [1 1/3']	A
	119	C: Drawbar 1'	10 ORGAN FOOTAGE slider [1']	A
			USB Audio Volume	

**Table A**

Parameters	Controller Value	
	Transmitted	Recognized
0-127	0-127	0-127

**Table B**

Parameters		Controller Value	
		Transmitted	Recognized
-12dB	52	0-5	0-5
-11dB	53	6-10	6-10
-10dB	54	11-15	11-15
-9dB	55	16-20	16-20
-8dB	56	21-25	21-25
-7dB	57	26-30	26-30
-6dB	58	31-35	31-35
-5dB	59	36-40	36-40
-4dB	60	41-46	41-46
-3dB	61	47-51	47-51
-2dB	62	52-56	52-56
-1dB	63	57-61	57-61
0dB	64	62-66	62-66
1dB	65	67-71	67-71
2dB	66	72-76	72-76
3dB	67	77-81	77-81
4dB	68	82-87	82-87
5dB	69	88-92	88-92
6dB	70	93-97	93-97
7dB	71	98-102	98-102
8dB	72	103-107	103-107
9dB	73	108-112	108-112
10dB	74	113-117	113-117
11dB	75	118-122	118-122
12dB	76	123-127	123-127

**Table C**

Parameters	Controller Value	
	Transmitted	Recognized
Slow	0	0-63
Stop	64	64
Fast	127	65-127

**Table D**

Parameters	Controller Value	
	Transmitted	Recognized
0	0	0
1	1-18	1-18
2	19-36	19-36
3	37-54	37-54
4	55-72	55-72
5	73-90	73-90
6	91-108	91-108
7	109-126	109-126
8	127	127

# MIDI Data Format

## 1 Scope

The specifications described herein apply to transmission and reception of MIDI data by a CK88 or CK61 Stage Keyboard.

## 2 Compliance

The specifications described herein comply with the MIDI 1.0 standard.

### (1) TRANSMIT FLOW

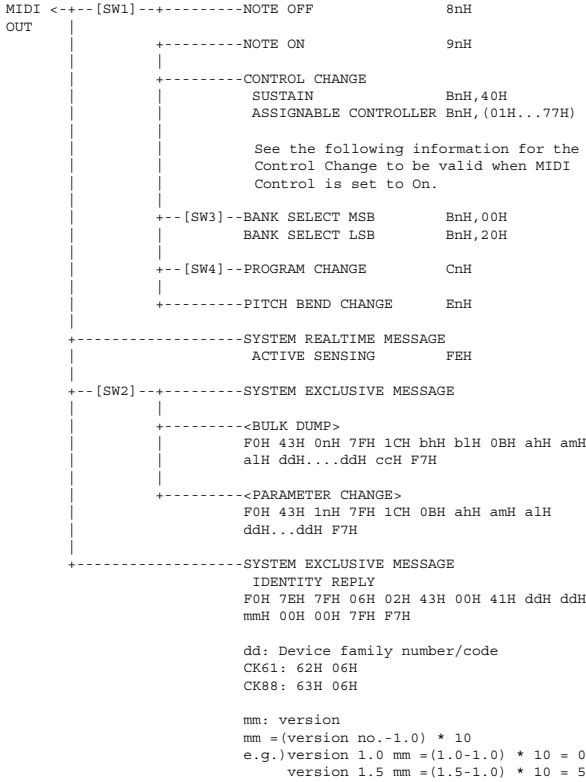

- [SW1] MIDI Transmit Channel  
Complies with Zone Transmit Channel when the Master Keyboard Mode SW is set to on.  
Complies with MIDI Transmit Channel in any other case.
- [SW2] SYSTEM MIDI Device Number  
When set to "all," transmitted via "1."
- [SW3] SYSTEM Bank Select Switch
- [SW4] SYSTEM Program Change Switch

### (2) RECEIVE FLOW

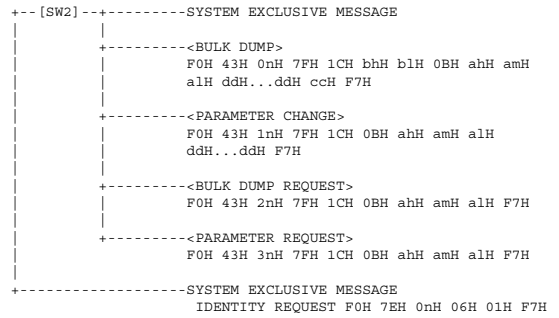
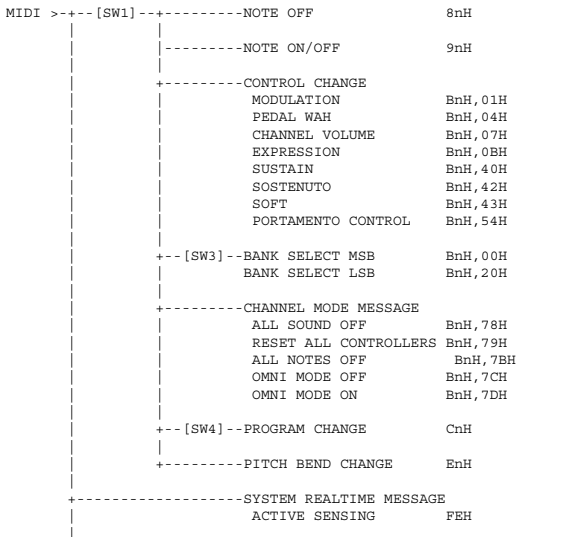

- [SW1] Complies with MIDI Receive Channel.
- [SW2] SYSTEM MIDI Device Number
- [SW3] SYSTEM Bank Select Switch
- [SW4] SYSTEM Program Change Switch

### (3) TRANSMIT/RECEIVE DATA

#### (3-1) CHANNEL VOICE MESSAGES

##### (3-1-1) NOTE OFF

STATUS	1000nnnn (9nH)	n = 0-15 CHANNEL NUMBER
NOTE No.	0kkkkkkkk	k = 0 (C-2)-127 (G8)
VELOCITY	0vvvvvvvv	v = 64 Transmit

##### (3-1-2) NOTE ON/OFF

STATUS	1000nnnn (8nH)	n = 0-15 CHANNEL NUMBER
NOTE No.	0kkkkkkkk	k = 0 (C-2)-127 (G8)
VELOCITY NOTE ON	0vvvvvvvv (v≠0)	
NOTE OFF	0vvvvvvvv (v=0)	

##### (3-1-3) CONTROL CHANGE

STATUS	1011nnnn (BnH)	n = 0-15 CHANNEL NUMBER
CONTROL NUMBER	0ccccccc	
CONTROL VALUE	0vvvvvvvv	

\*TRANSMITTED CONTROL NUMBER

c = 0	BANK SELECT MSB	; v = 0 - 127	*1
c = 32	BANK SELECT LSB	; v = 0 - 127	*1
c = 64	SUSTAIN	; v = 0 - 127	*3
c = 1..119	ASSIGNABLE CONTROLLER	; v = 0 - 127	*2

\*RECEIVED CONTROL NUMBER

c = 0	BANK SELECT MSB	; v = 0 - 127	*1
c = 32	BANK SELECT LSB	; v = 0 - 127	*1
c = 1	MODULATION	; v = 0 - 127	
c = 4	PEDAL WAH	; v = 0 - 127	
c = 7	CHANNEL VOLUME	; v = 0 - 127	
c = 11	EXPRESSION	; v = 0 - 127	
c = 64	SUSTAIN	; v = 0 - 127	
c = 66	SOSTENUTO	; v=0-63:OFF, 64-127:ON	
c = 67	SOFT	; v = 0 - 127	
c = 84	PORTAMENTO CONTROL	; v = 0 - 127	

\*1 Relation between BANK SELECT and PROGRAM is as follows:

	CATEGORY	MSB	LSB	PROGRAM No.
Live Set Page 1	:	63	0	0..7
Live Set Page 20	:	63	19	0..7

\*2 The default CONTROL NUMBERS of ASSIGNABLE CONTROLLER are as follows:

MODULATION WHEEL	1
FOOT PEDAL 1	64
FOOT PEDAL 2	11

\*3 Foot Pedal Type is set to FC3A (HalfOff) or FC4A/FC5, the foot pedal operation transmits the value 0 (off) or 127 (on).

Bank Select will be actually executed when a Program Change message is received. Bank Select and Program Change numbers that are not supported by this instrument will be ignored.

##### (3-1-4) PROGRAM CHANGE

STATUS	1100nnnn (CnH)	n = 0-15 CHANNEL NUMBER
PROGRAM NUMBER	00000ppp	p = 0-7

##### (3-1-5) PITCH BEND CHANGE

STATUS	1110nnnn (EnH)	n = 0-15 CHANNEL NUMBER
LSB	0vvvvvvvv	PITCH BEND CHANGE LSB
MSB	0vvvvvvvv	PITCH BEND CHANGE MSB

Transmitted with a resolution of 7 bits.

##### (3-2) CHANNEL MODE MESSAGES

STATUS	1011nnnn (BnH)	n = 0-15 CHANNEL NUMBER
CONTROL NUMBER	0ccccccc	c = CONTROL NUMBER
CONTROL VALUE	0vvvvvvvv	v = DATA VALUE

**(3-2-1) ALL SOUND OFF (CONTROL NUMBER = 78H, DATA VALUE = 0)**

All the sounds currently being played, including channel messages such as note-on of a certain channel, are muted this message is received.

**(3-2-2) RESET ALL CONTROLLERS (CONTROL NUMBER = 79H, DATA VALUE = 0)**

Resets the values set for the following controllers.

PITCH BEND CHANGE	0 (center)
MODULATION	0 (minimum)
PEDAL WAH	0 (minimum)
EXPRESSION	127 (maximum)
SUSTAIN	0 (off)
SOSTENUTO	0 (off)
SOFT	0 (off)
PORTAMENTO CONTROL	Clear the reserved note number

Doesn't reset the following data:

PROGRAM CHANGE, BANK SELECT MSB/LSB, VOLUME

**(3-2-3) ALL NOTES OFF (CONTROL NUMBER = 7BH, DATA VALUE = 0)**

All the notes currently set to on in certain channel(s) are muted when receiving this message. However, if Sustain or Sostenuto is on, notes will continue sounding until these are turned off.

**(3-2-4) OMNI MODE OFF (CONTROL NUMBER = 7CH, DATA VALUE = 0)**

Performs the same function as when receiving ALL NOTES OFF.

**(3-2-5) OMNI MODE ON (CONTROL NUMBER = 7DH, DATA VALUE = 0)**

Performs the same function as when receiving ALL NOTES OFF.

**(3-3) SYSTEM REAL TIME MESSAGES**

**(3-3-1) ACTIVE SENSING**

STATUS 11111110 (FEH)

Transmitted every 200 msec.

Once this code is received, the instrument starts sensing. When neither status messages nor data are received for more than approximately 350 ms, the MIDI receive buffer will be cleared, and the sounds currently being played are forcibly turned off.

**(3-4) SYSTEM EXCLUSIVE MESSAGE**

**(3-4-1) UNIVERSAL NON REALTIME MESSAGE**

**(3-4-1-1) IDENTITY REQUEST (Receive only)**

F0H 7EH 0nH 06H 01H F7H ("n" = Device No. However, this instrument receives under "omni.")

**(3-4-1-2) IDENTITY REPLY (Transmit only)**

F0H 7EH 7FH 06H 02H 43H 00H 41H ddH ddH mmH 00H 00H 7FH F7H

dd: Device family number/code  
 CK61: 62H 06H  
 CK88: 63H 06H

mm: version  
 mm = (version no. - 1.0) \* 10  
 e.g.) version 1.0 mm = (1.0 - 1.0) \* 10 = 0  
 version 1.5 mm = (1.5 - 1.0) \* 10 = 5

**(3-4-2) UNIVERSAL REALTIME MESSAGE**

**(3-4-3) PARAMETER CHANGE**

**(3-4-3-1) NATIVE PARAMETER CHANGE, MODE CHANGE**

11110000	F0	Exclusive status
01000011	43	YAMAHA ID
0001nnnn	1n	Device Number
01111111	7F	Group ID High
00011100	1C	Group ID Low
00001011	0B	Model ID
0aaaaaaaa	aaaaaaa	Address High
0aaaaaaaa	aaaaaaa	Address Mid
0aaaaaaaa	aaaaaaa	Address Low
0ddddddd	ddddddd	Data
11110111	F7	End of Exclusive

For parameters with data size of 2 or more, the appropriate number of data bytes will be transmitted.

See the following MIDI Data Table for Address.

**(3-4-4) BULK DUMP**

11110000	F0	Exclusive status
01000011	43	YAMAHA ID
0000nnnn	0n	Device Number
01111111	7F	Group ID High
00011100	1C	Group ID Low
0bbbbbbb	bbbbbbb	Byte Count
0bbbbbbb	bbbbbbb	Byte Count
00001011	0B	Model ID
0aaaaaaaa	aaaaaaa	Address High
0aaaaaaaa	aaaaaaa	Address Mid
0aaaaaaaa	aaaaaaa	Address Low
0	0	Data
0ccccccc	ccccccc	Check-sum
11110111	F7	End of Exclusive

See the following MIDI Data Table for Address and Byte Count. Checksum is the value that results in a value of 0 for the lower 7 bits when the Byte Count, Start Address, Data and Checksum itself are added.

**(3-4-5) DUMP REQUEST**

11110000	F0	Exclusive status
01000011	43	YAMAHA ID
0010nnnn	2n	Device Number
01111111	7F	Group ID High
00011100	1C	Group ID Low
00001011	0B	Model ID
0aaaaaaaa	aaaaaaa	Address High
0aaaaaaaa	aaaaaaa	Address Mid
0aaaaaaaa	aaaaaaa	Address Low
11110111	F7	End of Exclusive

See the following MIDI Data Table for Address.

**(3-4-6) PARAMETER REQUEST**

11110000	F0	Exclusive status
01000011	43	YAMAHA ID
0011nnnn	3n	Device Number
01111111	7F	Group ID High
00011100	1C	Group ID Low
00001011	0B	Model ID
0aaaaaaaa	aaaaaaa	Address High
0aaaaaaaa	aaaaaaa	Address Mid
0aaaaaaaa	aaaaaaa	Address Low
11110111	F7	End of Exclusive

See the following MIDI Data Table for Address.

**(4) SYSTEM OVERVIEW (Keyboard and Tone Generator)**

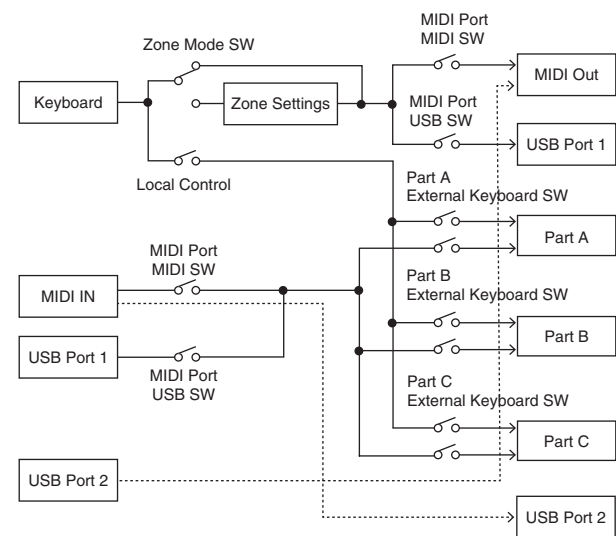

USB Port 2 is enabled when 'MIDI Port MIDI SW = OFF' and 'MIDI Port USB SW = ON'

ALL SOUND OFF clears all the sounds in the specific channel(s) played by both the keyboard and the data via MIDI.  
 ALL NOTES OFF received via MIDI clears the sounds in the specific channel(s) played via MIDI.

# MIDI Data Table

## Bank Select

MSB		LSB		Program No.	Type	Memory	Description
DEC	HEX	DEC	HEX				
63	3F	0	00	0-7	Live Set Sound	User	Live Set Page 1
		1	01	0-7		User	Live Set Page 2
		2	02	0-7		User	Live Set Page 3
		3	03	0-7		User	Live Set Page 4
		4	04	0-7		User	Live Set Page 5
		5	05	0-7		User	Live Set Page 6
		6	06	0-7		User	Live Set Page 7
		7	07	0-7		User	Live Set Page 8
		8	08	0-7		User	Live Set Page 9
		9	09	0-7		User	Live Set Page 10
		10	0A	0-7		User	Live Set Page 11
		11	0B	0-7		User	Live Set Page 12
		12	0C	0-7		User	Live Set Page 13
		13	0D	0-7		User	Live Set Page 14
		14	0E	0-7		User	Live Set Page 15
		15	0F	0-7		User	Live Set Page 16
		16	10	0-7		User	Live Set Page 17
		17	11	0-7		User	Live Set Page 18
		18	12	0-7		User	Live Set Page 19
19	13	0-7	User	Live Set Page 20			

## Bulk Dump Block

“Top Address” indicates the top address of each block designated by the bulk dump operation. “Byte Count” indicates the data size contained in each block designated by the bulk dump operation.

The block from the Bulk Header to the Bulk Footer of the Live Set Sound can be received regardless of their order; however, they cannot be received if an irrelevant Block is included. To execute 1 Live Set Sound bulk dump request, designate its corresponding Bulk Header address.

For information about “pp” and “n” shown in the following list, refer to the MIDI PARAMETER CHANGE TABLE (BULK CONTROL).

Group Number = 7F 1C, Model ID = 0B

Parameter Block	Description	Byte Count		Top Address			
		DEC	HEX	High	Mid	Low	
System	Common	56	38	20	00	00	
	Master EQ	20	14	20	40	00	
Live Set Sound	Bulk Header	0	00	0E	pp	0n	
	Soundmondo Format Version	4	04	00	7F	00	
	Common	Common	83	53	46	00	00
		Live Set EQ	20	14	46	40	00
		Audio Trigger	255	FF	46	10	00
	Zone	Zone 1	16	10	4A	00	00
		:				:	
		Zone 4				03	
	Part	Part A	105	69	50	00	00
		Part B				01	
Part C					02		
	Bulk Footer	0	00	0F	pp	0n	

## Parameter Base Address

Group Number = 7F 1C, Model ID = 0B

Parameter Block	Top Address			Description
	High	Mid	Low	
	System	20	00	
	20	40	00	Master EQ
	00	7F	00	Soundmondo Format Version
BULK CONTROL	0E	00	00	Header
	0F	00	00	Footer
STORE TO FLASH	0D	00	00	Store To Flash
Live Set Common	46	00	00	Common
	46	40	00	Live Set EQ
	46	10	00	Audio Trigger Path
	4A	zz	00	Zone (zz: 00-03)
Live Set Part	50	0p	00	Part

Message Type	Data
Parameter Change	F0, 43, 1n, gh, gl, id, ah, am, al, dt, ... F7
Parameter Request	F0, 43, 3n, gh, gl, id, ah, am, al F7
Bulk Dump	F0, 43, 0n, gh, gl, bh, bl, id, ah, am, al, dt, ..., cc, F7
Bulk Request	F0, 43, 2n, gh, gl, id, ah, am, al, F7

- n: Device Number
- gh: Group Number High
- gl: Group Number Low
- bh: Byte Count High
- bl: Byte Count Low
- id: Model ID
- ah: Parameter Address High
- am: Parameter Address Middle
- al: Parameter Address Low
- dt: Data
- cc: Data Checksum



## MIDI PARAMETER CHANGE TABLE (BULK CONTROL)

Group Number = 7F 1C, Model ID = 0B

Address			Size	Data Range (HEX)	Parameter Name	Description	Default (HEX)	Notes
High	Mid	Low						
0E	pp	0n	1	-	Bulk Header	Live Set Sound User (pp = 0-19, n = 0-7)	-	
	7F	00	1	-		Current Sound Buffer	-	
0F	pp	0n	1	-	Bulk Footer	Live Set Sound User (pp = 0-19, n = 0-7)	-	
	7F	00	1	-		Current Sound Buffer	-	

## SYSTEM

### Common

Group Number = 7F 1C, Model ID = 0B

Address			Size	Data Range	Parameter Name	Description	Default (HEX)	Notes
High	Mid	Low						
20	00	00	1		reserved			
		01	1		reserved			
		02	4	00-00 00-07 00-0F 00-0F	Master Tune	414.72-466.78 [Hz] 1st bit3-0: bit15-12 2nd bit3-0: bit11-8 3rd bit3-0: bit 7-4 4th bit3-0: bit 3-0	00 04 00 00	
		06	1	3D-43	Keyboard Octave Shift	-3-0+3	40	Excluded from the save operation
		07	1	34-4C	Keyboard Transpose	-12+12 [semitones]	40	Excluded from the save operation
		08	1	00-01	Controller Reset	Hold, Reset	01	
		09	1	00-01	Local Control	Off, On	01	
		0A	1	00-0F, 7F	Tx Channel	1-16, Off	00	
		0B	1	00-10	Rx Channel	1-16, All	00	
		0C	1	00-01	MIDI Control	Off, On	00	
		0D	1		reserved			
		0E	1	38-48	Output Gain	-24-0+24 [dB]	3E	
		0F	1		reserved			
		10	1	00-04	Keyboard Touch Curve	Normal, Soft, Hard, Wide, Fixed	00	
		11	1	01-7F	Keyboard Fixed Velocity	1-127	40	
		12	1	00-01	Transmit/Receive Bank Select	Off, On	01	
		13	1	00-01	Transmit/Receive Program Change	Off, On	01	
		14	1		reserved			
		15	1	00-01	MIDI In/Out	Off, On	01	
		16	1	00-01	USB In/Out	Off, On	01	
		17	1		reserved			
		18	1		reserved			
		19	1		reserved			
		1A	1		reserved			
		1B	1	00-01	Value Indication	Off, On	01	
		1C	1	00-01	Controller Mode	Jump, Catch	00	
		1D	1		reserved			
		1E	1	00-01	LCD Switch	Off, On	01	
		1F	1	36-4A	LCD Contrast	-10-0+10	40	
		20	1	00-01	Panel Lock Live Set	Off, On	01	
		21	1	00-01	Panel Lock Organ	Off, On	01	
		22	1	00-01	Panel Lock Filter/EG	Off, On	01	
		23	1	00-01	Panel Lock Drive/Effect	Off, On	01	
		24	1	00-01	Panel Lock Delay/Reverb	Off, On	01	
		25	1	00-01	Panel Lock Equalizer	Off, On	01	
		26	1		reserved			
		27	1		reserved			

Address			Size	Data Range	Parameter Name	Description	Default (HEX)	Notes
High	Mid	Low						
		28	1	00-13	Power On Page	1-20	00	
		29	1	00-07	Power On Sound	1-8	00	
		2A	1	00-03	Foot Pedal 1- Pedal Type	FC3A (Half On), FC3A (HalfOff), FC4A/FC5, FC7	00	
		2B	1	00-02	Foot Pedal 1-Live Set Inc/Dec	Off, Live Set Inc, Live Set Dec	00	
		2C	1	00-03	Foot Pedal 2- Pedal Type	FC3A (Half On), FC3A (HalfOff), FC4A/FC5, FC7	03	
		2D	1	00-02	Foot Pedal 2-Live Set Inc/Dec	Off, Live Set Inc, Live Set Dec	00	
		2E	1	00-01	Filter/EG Reset	Off, On	01	
		2F	1	00-01	Effect On/Off Reset	Off, On	01	
		30	1	00-02	reserved			
		31	1		USB Audio Volume	0-127	40	
		32	1	00-7F	Bluetooth Volume	0-127	40	
		33	1	00-7F	A/D Input Type	Mic, Line	01	
		34	1	00-01	USB Audio Loopback	Off, On	00	
		35	1		reserved			
		36	1	00-01	Speaker EQ	Normal, Table	00	
		37	1	00-01	Speaker Mute	Auto, Manual	00	

TOTAL SIZE = 56 38 (HEX)

### Master EQ

Address			Size	Data Range	Parameter Name	Description	Default (HEX)	Notes
High	Mid	Low						
20	40	00	1	34-4C	Low Gain	-12dB+12dB	40	Excluded from the save operation
		01	1	04-28	Low Frequency	32Hz-2.0kHz	0C	
		02	1		reserved			
		03	1		reserved			
		04	1		reserved			
		05	1		reserved			
		06	1		reserved			
		07	1		reserved			
		08	1	34-4C	Mid Gain	-12dB+12dB	40	Excluded from the save operation
		09	1	0E-36	Mid Frequency	100Hz-10kHz	22	
		0A	1		reserved			
		0B	1		reserved			
		0C	1		reserved			
		0D	1		reserved			
		0E	1		reserved			
		0F	1		reserved			
		10	1	34-4C	High Gain	-12dB+12dB	40	Excluded from the save operation
		11	1	1C-3A	High Frequency	500Hz-16kHz	30	
		12	1		reserved			
		13	1		reserved			

TOTAL SIZE = 20 14 (HEX)

### Soundmondo Format Version

Address			Size	Data Range	Parameter Name	Description	Default (HEX)	Notes
High	Mid	Low						
00	7F	00	1	00-7F	Soundmondo Format Version Major		01	
			1	00-7F	Soundmondo Format Version Minor		00	
			1	00-7F	Soundmondo Format Version Bugfix		00	
			1		reserved		00	

TOTAL SIZE = 4 4 (HEX)

# Live Set Common

## Common

Group Number = 7F 1C, Model ID = 0B

Address			Size	Data Range	Parameter Name	Description	Default (HEX)	Notes
High	Mid	Low						
46	00	00	1	20-7E	Live Set Sound Name 1	32-126 (ASCII)	49	'i'
		01	1	20-7E	Live Set Sound Name 2	32-126 (ASCII)	6E	'n'
		02	1	20-7E	Live Set Sound Name 3	32-126 (ASCII)	69	'i'
		03	1	20-7E	Live Set Sound Name 4	32-126 (ASCII)	74	't'
		04	1	20-7E	Live Set Sound Name 5	32-126 (ASCII)	20	' '
		05	1	20-7E	Live Set Sound Name 6	32-126 (ASCII)	53	'S'
		06	1	20-7E	Live Set Sound Name 7	32-126 (ASCII)	6F	'o'
		07	1	20-7E	Live Set Sound Name 8	32-126 (ASCII)	75	'u'
		08	1	20-7E	Live Set Sound Name 9	32-126 (ASCII)	6E	'n'
		09	1	20-7E	Live Set Sound Name 10	32-126 (ASCII)	64	'd'
		0A	1	20-7E	Live Set Sound Name 11	32-126 (ASCII)	20	
		0B	1	20-7E	Live Set Sound Name 12	32-126 (ASCII)	20	
		0C	1	20-7E	Live Set Sound Name 13	32-126 (ASCII)	20	
		0D	1	20-7E	Live Set Sound Name 14	32-126 (ASCII)	20	
		0E	1	20-7E	Live Set Sound Name 15	32-126 (ASCII)	20	
		0F	1		reserved			
		10	1	00-01	Live Set EQ Mode Switch	Off, On	00	
		11	1	00-01	Master Keyboard Mode Switch	Off, On	00	
		12	1	00-01	Advanced Zone Switch	Off, On	00	
		13	2	00-12 00-7F	Tempo	42.0-240.0 1st bit6-0 → bit13-7 2nd bit6-0 → bit6-0	09 30	
		15	1	34-4C	Sound Transpose	-12-+12	40	
		16	1	00-03	Layer Split Mode	ABC, A/BC, AB/C, A/B/C	00	
		17	1		reserved			
		18	1	01-7F	Split Point	C#-2-G8	37	Only for splitting in two
		19	1	01-7E	Split Point A-B	C#-2-F#8	37	Only for splitting in three
		1A	1	02-7F	Split Point B-C	D-2-G8	4F	Only for splitting in three
		1B	1		reserved			
		1C	1	00-78	Modulation Wheel Assign	0-119, 120 (USB Audio Volume) For more information, see "Control Change Number" (page 54).	01	
		1D	1		reserved			
		1E	1		reserved			
		1F	1	00-78	Foot Pedal 1 Assign	0-119, 120 (USB Audio Volume) For more information, see "Control Change Number" (page 54).	40	
		20	1	00-7F	Foot Pedal 1 Limit Low	0-127	00	
		21	1	00-7F	Foot Pedal 1 Limit High	0-127	7F	

Address			Size	Data Range	Parameter Name	Description	Default (HEX)	Notes
High	Mid	Low						
		22	1	00-78	Foot Pedal 2 Assign	0-119, 120 (USB Audio Volume) For more information, see "Control Change Number" (page 54).	0B	
		23	1	00-7F	Foot Pedal 2 Limit Low	0-127	00	
		24	1	00-7F	Foot Pedal 2 Limit High	0-127	7F	
		25	1		reserved			
		26	1		reserved			
		27	1	00-01	Delay Switch	Off, On	00	
		28	1	00-03	Delay Type	Digital Delay, Analog Delay, Cross Delay, Tempo Delay	00	
		29	1	00-7F	Delay Depth	0-127	40	
		2A	1	00-7F	Delay Time	0-127	40	
		2B	1	00-0E	Delay Tempo Delay Time	1/32 Tri., 1/64 Dot., 1/32, 1/16 Tri., 1/32 Dot., 1/16, 1/8 Tri., 1/16 Dot, 1/8, 1/4 Tri., 1/8 Dot., 1/4, 1/2 Tri., 1/4 Dot., 1/2	0B	
		2C	1	00-01	Reverb Switch	Off, On	01	
		2D	1	00-02	Reverb Type	Hall Reverb, Room Reverb, Plate Reverb	00	
		2E	1	00-7F	Reverb Depth	0-127	14	
		2F	1		reserved			
		30	1	00-01	Rotary Speaker Slow/Fast	Slow, Fast	00	
		31	1	00-01	Rotary Speaker Stop	Off, On	00	
		32	1		reserved			
		33	1	00-01	Audio Trigger Switch	Off, On	00	
		34	1	00-7F	Audio Trigger Volume	0-127	40	
		35	1	00-01	Audio Trigger Key Assign	Lowest, Highest	01	
		36	1	00-02	Audio Trigger Play Mode	One Shot, Play/Stop, Play/Pause	00	
		37	1		reserved			
		38	1	04-28	A/D Input-EQ Low Freq	32 Hz-2.0 kHz	12	
		39	1	34-4C	A/D Input-EQ Low Gain	-12 dB-+12 dB	40	
		3A	1	0E-36	A/D Input-EQ Mid Freq	100 Hz-10 kHz	29	
		3B	1	34-4C	A/D Input-EQ Mid Gain	-12 dB-+12 dB	40	
		3C	1	1C-3A	A/D Input-EQ High Freq	500 Hz-16 kHz	34	
		3D	1	34-4C	A/D Input-EQ High Gain	-12 dB-+12 dB	40	
		3E	1	00-01	A/D Input-Noise Gate Switch	Off, On	00	
		3F	1	36-61	A/D Input-Noise Gate Threshold	-73 dB-30 dB	52	
		40	1		reserved			
		41	1		reserved			
		42	1		reserved			
		43	1		reserved			
		44	1		reserved			
		45	1	00-22	A/D Input-Effect 1 Type	*1	00	
		46	1	00-7F	A/D Input-Effect 1 Depth	0-127	40	
		47	1	00-7F	A/D Input-Effect 1 Rate	0-127	40	
		48	1		reserved			
		49	1	00-22	A/D Input-Effect 2 Type	*1	00	

Address			Size	Data Range	Parameter Name	Description	Default (HEX)	Notes
High	Mid	Low						
		4A	1	00-7F	A/D Input-Effect 2 Depth	0-127	40	
		4B	1	00-7F	A/D Input-Effect 2 Rate	0-127	40	
		4C	1	00-7F	A/D Input-Volume	0-127	7F	
		4D	1		reserved			
		4E	1		reserved			
		4F	1		reserved			
		50	1		reserved			
		51	1		reserved			
		52	1		reserved			

TOTAL SIZE = 83 53 (HEX)

\*1: G Chorus, SPX Chorus, Symphonic, 816 Chorus, VCM Flanger, Cross FB Flanger, VCM Stereo Phaser, Small Phaser, Max90, Dual Phaser, Tremolo, Auto Pan, Simple Rotary, British Combo, British Lead, Small Stereo, Compressor, Tone Control, 1 BandEQ Narrow, 1 BandEQ Wide, Auto Wah, Touch Wah, Cross Delay, Digital Delay, Analog Delay, Room Reverb, Hall Reverb, Reverse Reverb, Ring Modulator, Slicer, LP Filter, HP Filter, Lo-Fi, Harmonic Enhancer

### Live Set EQ

Address			Size	Data Range	Parameter Name	Description	Default (HEX)	Notes
High	Mid	Low						
46	40	00	1	34-4C	Low Gain	-12 dB→+12 dB	40	
		01	1	04-28	Low Frequency	32 Hz-2.0 kHz	0C	
		02	1		reserved			
		03	1		reserved			
		04	1		reserved			
		05	1		reserved			
		06	1		reserved			
		07	1		reserved			
		08	1	34-4C	Mid Gain	-12 dB→+12 dB	40	
		09	1	0E-36	Mid Frequency	100 Hz-10 kHz	22	
		0A	1		reserved			
		0B	1		reserved			
		0C	1		reserved			
		0D	1		reserved			
		0E	1		reserved			
		0F	1		reserved			
		10	1	34-4C	High Gain	-12 dB→+12 dB	40	
		11	1	1C-3A	High Frequency	500 Hz-16 kHz	30	
		12	1		reserved			
		13	1		reserved			

TOTAL SIZE = 20 14 (HEX)

### Audio Trigger

Address			Size	Data Range	Parameter Name	Description	Default (HEX)	Notes
High	Mid	Low						
46	10	00	255 at the maximum		Wave File Path	32-127 (ASCII)		

TOTAL SIZE = 255 FF (HEX)

## ZONE

### Zone

Group Number = 7F 1C, Model ID = 0B

Address			Size	Data Range	Parameter Name	Description	Default (HEX)	Notes
High	Mid	Low						
4A	zz	00	1	00-01	Zone Switch	Off, On	00-01	With Default, only Zone 1 is ON.
		01	1	00-0F	Transmit Channel	1-16	00-03	With Default, Zone 1 is 0, Zone 2 is 1, Zone 3 is 2, and Zone 4 is 3.
		02	1	3D-43	Transpose (Octave)	-3→+3	40	
		03	1	35-4B	Transpose (Semitone)	-11→+11	40	
		04	1	00-7F	Note Limit Low	C-2-G8	00	The highest value is defined with Note Limit High.
		05	1	00-7F	Note Limit High	C-2-G8	7F	The lowest value is defined with Note Limit Low.
		06	1		reserved			
		07	1	00-7F	MIDI Volume	0-127	7F	
		08	1	00-7F	MIDI Pan	L64-C-R63	40	
		09	1	00-7F	MIDI Bank MSB	000-127	00	
		0A	1	00-7F	MIDI Bank LSB	000-127	00	
		0B	1	00-7F	MIDI Program Number	001-128	00	
		0C	1	00-1F	Transmit Bank Select Transmit Program Change Transmit Volume Transmit Pan	bit0: Off, On Bank Select bit1: Off, On Program Change bit2: Off, On Volume bit3: Off, On Pan	1F	When the Volume is Off, CC#11 (Expression) will not be transmitted.
		0D	1	00-3F	Transmit PB Transmit Mod Transmit Foot Pedal 1 Transmit Foot Pedal 2	bit0: Off, On PB bit1: Off, On Mod bit2: Off, On Foot Pedal 1 bit3: Off, On Foot Pedal 2	0F	
		0E	1		reserved			
		0F	1		reserved			

TOTAL SIZE = 16 10 (HEX)

zz = Zone Number  
00-03 (HEX)

# Live Set Part

## Part

Group Number = 7F 1C, Model ID = 0B

Address			Size	Data Range (HEX)	Parameter Name	Description	Default (HEX)	Notes
High	Mid	Low						
50	0p	00	1	00-09	Current Category		00	
		01	2	00-7F 00-7F	Category 1 Voice Number	0-12 1st bit6-0 → bit13-7 2nd bit6-0 → bit6-0	00 00	Piano
		03	2	00-7F 00-7F	Category 2 Voice Number	13-26 1st bit6-0 → bit13-7 2nd bit6-0 → bit6-0	00 00	E.Piano
		05	2	00-7F 00-7F	Category 3 Voice Number	27-46 1st bit6-0 → bit13-7 2nd bit6-0 → bit6-0	00 00	Organ
		07	2	00-7F 00-7F	Category 4 Voice Number	47-108 1st bit6-0 → bit13-7 2nd bit6-0 → bit6-0	00 00	Brs/ Wind
		09	2	00-7F 00-7F	Category 5 Voice Number	109-166 1st bit6-0 → bit13-7 2nd bit6-0 → bit6-0	00 00	Gtr/Bass
		0B	2	00-7F 00-7F	Category 6 Voice Number	167-208 1st bit6-0 → bit13-7 2nd bit6-0 → bit6-0	00 00	Strings
		0D	2	00-7F 00-7F	Category 7 Voice Number	209-273 1st bit6-0 → bit13-7 2nd bit6-0 → bit6-0	00 00	Pad
		0F	2	00-7F 00-7F	Category 8 Voice Number	274-324 1st bit6-0 → bit13-7 2nd bit6-0 → bit6-0	00 00	Lead
		11	2	00-7F 00-7F	Category 9 Voice Number	325-350 1st bit6-0 → bit13-7 2nd bit6-0 → bit6-0	00 00	Chr.Perc
		13	2	00-7F 00-7F	Category 10 Voice Number	351-362 1st bit6-0 → bit13-7 2nd bit6-0 → bit6-0	00 00	Others
		15	1		reserved			
		16	1	28-58	Note Shift	-24-0-+24	40	
		17	1	00-7F	Part Volume	0-127	7F	
		18	1	00-0B	Part Color	0: Red, 1: Orange, 2: Yellow, 3: Lime, 4: Green, 5: Spring, 6: Cyan, 7: Azure, 8: Blue, 9: Violet, 10: Magenta, 11: Rose	A: 02, B: 08, C: 04	
		19	1	00-01	Part Switch	Off, On	A: 01, B: 00, C: 00	
		1A	1	00-01	Part Selected	Off, On	A: 01, B: 00, C: 00	
		1B	1	00-01	Effect Select	0: Effect1, 1: Effect2	00	
		1C	1		reserved			
		1D	1		reserved			
		1E	1		reserved			
		1F	1		reserved			
		20	1	00-01	Mono/Poly	Mono, Poly	01	
		21	1	00-02	Mono Type	Normal, Fingered Portamento, Full-time Portamento	00	Invalid for Organ Flute voice
		22	1		reserved			

Address			Size	Data Range (HEX)	Parameter Name	Description	Default (HEX)	Notes
High	Mid	Low						
		23	1	00-7F	Portamento Time	0-127	14	Invalid for Organ Flute voice (for both Portamento Time and Portamento Time Mode)
		24	1	00-01	Portamento Time Mode	Rate, Time	00	
		25	1		reserved			
		26	1		reserved			
		27	1		reserved			
		28	1		reserved			
		29	1		reserved			
		2A	1		reserved			
		2B	1		reserved			
		2C	1	00-01	Unison Switch	Off, On	00	
		2D	1	00-02	Unison Type	Multi Layer, Harmonics, Sub Harmonics	00	
		2E	1	00-7F	Unison Volume	0-127	7F	
		2F	1	00-7F	Unison Detune	0-127	40	
		30	1	28-58	Pitch Bend Range	-24-0-+24	42	
		31	1	00-7F	Pitch Modulation Depth	0-127	0A	
		32	1	00-7F	Amplifier Modulation Depth	0-127	00	
		33	1	00-7F	Filter Modulation Depth	0-127	00	
		34	1	00-7F	Modulation Speed	-64-0-+63	40	
		35	1	00-01	Receive Expression	Off, On	01	
		36	1	00-01	Receive Sustain	Off, On	01	
		37	1	00-01	Receive Sostenuto	Off, On	01	
		38	1	00-01	Receive Soft	Off, On	01	
		39	1	00-02	External Keyboard	Ext+Int, ExtOnly, Off	00	
		3A	1	00-7F	Touch Sensitivity Depth	0-127	40	
		3B	1	00-7F	Touch Sensitivity Offset	0-127	40	
		3C	1		reserved			
		3D	1		reserved			
		3E	1		reserved			
		3F	1		reserved			
		40	1	00-7F	Drawbar 16'	0-127	7F	Correlation between the drawbar positions and parameter values 0: 0 1: 1-18 2: 19-36 3: 37-54 4: 55-72 5: 73-90 6: 91-108 7: 109-126 8: 127
		41	1	00-7F	Drawbar 5 1/3'	0-127	7F	
		42	1	00-7F	Drawbar 8'	0-127	7F	
		43	1	00-7F	Drawbar 4'	0-127	00	
		44	1	00-7F	Drawbar 2 2/3'	0-127	00	
		45	1	00-7F	Drawbar 2'	0-127	00	
		46	1	00-7F	Drawbar 1 3/5'	0-127	00	
		47	1	00-7F	Drawbar 1 1/3'	0-127	00	
		48	1	00-7F	Drawbar 1'	0-127	00	
		49	1	00-01	Percussion Switch	Off, On	00	
		4A	1	00-01	Percussion Type	3rd, 2nd	00	
		4B	1	00-01	Percussion Decay	Slow, Fast	00	
		4C	1	00-01	Percussion Volume	Normal, Soft	00	
		4D	1		reserved			
		4E	1	00-01	Vibrato/Chorus Switch	Off, On	00	
		4F	1	00-05	Vibrato/Chorus Type	V1, C1, V2, C2, V3, C3	05	
		50	1	00-01	Filter Switch	Off, On	01	
		51	1	00-7F	Filter Cutoff	0-127	40	
		52	1	00-7F	Filter Resonance	0-127	40	
		53	1	00-01	EG Switch	Off, On	01	
		54	1	00-7F	EG Attack	0-127	40	
		55	1	00-7F	EG Release	0-127	40	

Address			Size	Data Range (HEX)	Parameter Name	Description	Default (HEX)	Notes
High	Mid	Low						
		56	1	00-01	Drive Switch	Off, On	00	
		57	1	00-04	Drive Type	0.Drive, Dist, Rotary A, Rotary B, Comp	00	
		58	1	00-7F	Drive Depth	0-127	40	
		59	1	00-01	Effect 1 Switch	Off, On	00	
		5A	1	00-23	Effect 1 Type	*2	00	
		5B	1	00-7F	Effect 1 Depth	0-127	40	
		5C	1	00-7F	Effect 1 Rate	0-127	40	
		5D	1	00-01	Effect 2 Switch	Off, On	00	
		5E	1	00-23	Effect 2 Type	*2	00	
		5F	1	00-7F	Effect 2 Depth	0-127	40	
		60	1	00-7F	Effect 2 Rate	0-127	40	
		61	1		reserved			
		62	1		reserved			
		63	1		reserved			
		64	1		reserved			
		65	1		reserved			
		66	1		reserved			
		67	1		reserved			
		68	1		reserved			

TOTAL SIZE = 105      69 (HEX)

p = Part number  
0-2 0: A, 1: B, 2: C

\*2: G Chorus, SPX Chorus, Symphonic, 816 Chorus, VCM Flanger, Cross FB Flanger, VCM Stereo Phaser, Small Phaser, Max90, Dual Phaser, Tremolo, Auto Pan, Simple Rotary, British Combo, British Lead, Small Stereo, Compressor, Tone Control, 1 BandEQ Narrow, 1 BandEQ Wide, Auto Wah, Touch Wah, Pedal Wah, Cross Delay, Digital Delay, Analog Delay, Room Reverb, Hall Reverb, Reverse Reverb, Ring Modulator, Slicer, LP Filter, HP Filter, Lo-Fi, Damper Resonance, Harmonic Enhancer

YAMAHA [Stage Keyboard]  
Model CK88 CK61 MIDI Implementation Chart

Date :16-JUL-2021  
Version : 1.0

Function...	Transmitted	Recognized	Remarks	
Basic Channel	Default Changed	1 - 16 1 - 16	1 - 16 1 - 16	Memorized
Mode	Default Messages Altered	3 X *****	3 X X	Memorized
Note Number : True voice		0 - 127 *****	0 - 127 0 - 127	
Velocity	Note On Note Off	O 9nH, v=1-127 X 8nH, v=64	O 9nH, v=1-127 O 9nH, v=0 or 8nH	
After Touch	Key's Ch's	X X	X X	
Pitch Bend		O	O	
Control Change	0,32 1 7,11,67,84 64 66 9,12-31 68-83 85-93 102-119 1-119	O *2 O X O X O *1 O *1 O *1 O *1 O *1 O *3	O *2 O O O *2 O *2 O *1 O *1 O *1 O *1 X	Bank Select  Sustain Sw Sostenuto
Prog Change : True #		O 0 - 127 *2	O 0 - 7 *2	
System Exclusive		O	O	
Common	: Song Pos. : Song Sel. : Tune	X X X	X X X	
System Real Time	: Clock : Commands	X X	X X	
Aux Messages	: All Sound Off : Reset All Cntrls : Local On/Off : All Notes Off : Active Sense : Reset	X X X X O X	O (120) O (121) X O (123-125) O X	
Notes: *1 receive/transmit if MIDI control mode is on. *2 receive/transmit if switch is on. *3 transmit if assigned to controllers.				

Mode 1 : OMNI ON , POLY  
Mode 3 : OMNI OFF, POLY

Mode 2 : OMNI ON ,MONO  
Mode 4 : OMNI OFF,MONO

O : Yes  
X : No

## Apache License 2.0

Copyright (c) 2009-2018 Arm Limited. All rights reserved.

SPDX-License-Identifier: Apache-2.0

Licensed under the Apache License, Version 2.0 (the License); you may not use this file except in compliance with the License. You may obtain a copy of the License at [www.apache.org/licenses/LICENSE-2.0](http://www.apache.org/licenses/LICENSE-2.0)

Unless required by applicable law or agreed to in writing, software distributed under the License is distributed on an AS IS BASIS, WITHOUT WARRANTIES OR CONDITIONS OF ANY KIND, either express or implied. See the License for the specific language governing permissions and limitations under the License.

## The Clear BSD license

The Clear BSD License  
Copyright 1997-2016 Freescale Semiconductor, Inc.  
Copyright 2016-2018 NXP  
All rights reserved.

Redistribution and use in source and binary forms, with or without modification, are permitted (subject to the limitations in the disclaimer below) provided that the following conditions are met:

Redistributions of source code must retain the above copyright notice, this list of conditions and the following disclaimer.

Redistributions in binary form must reproduce the above copyright notice, this list of conditions and the following disclaimer in the documentation and/or other materials provided with the distribution.

Neither the name of the copyright holder nor the names of its contributors may be used to endorse or promote products derived from this software without specific prior written permission.

NO EXPRESS OR IMPLIED LICENSES TO ANY PARTY'S PATENT RIGHTS ARE GRANTED BY THIS LICENSE. THIS SOFTWARE IS PROVIDED BY THE COPYRIGHT HOLDERS AND CONTRIBUTORS "AS IS" AND ANY EXPRESS OR IMPLIED WARRANTIES, INCLUDING, BUT NOT LIMITED TO, THE IMPLIED WARRANTIES OF MERCHANTABILITY AND FITNESS FOR A PARTICULAR PURPOSE ARE DISCLAIMED. IN NO EVENT SHALL THE COPYRIGHT HOLDER OR CONTRIBUTORS BE LIABLE FOR ANY DIRECT, INDIRECT, INCIDENTAL, SPECIAL, EXEMPLARY, OR CONSEQUENTIAL DAMAGES (INCLUDING, BUT NOT LIMITED TO, PROCUREMENT OF SUBSTITUTE GOODS OR SERVICES; LOSS OF USE, DATA, OR PROFITS; OR BUSINESS INTERRUPTION) HOWEVER CAUSED AND ON ANY THEORY OF LIABILITY, WHETHER IN CONTRACT, STRICT LIABILITY, OR TORT (INCLUDING NEGLIGENCE OR OTHERWISE) ARISING IN ANY WAY OUT OF THE USE OF THIS SOFTWARE, EVEN IF ADVISED OF THE POSSIBILITY OF SUCH DAMAGE.

## Modified BSD license

COPYRIGHT(c) 2016 STMicroelectronics

Redistribution and use in source and binary forms, with or without modification,

are permitted provided that the following conditions are met:

1. Redistributions of source code must retain the above copyright notice, this list of conditions and the following disclaimer.
2. Redistributions in binary form must reproduce the above copyright notice, this list of conditions and the following disclaimer in the documentation and/or other materials provided with the distribution.
3. Neither the name of STMicroelectronics nor the names of its contributors may be used to endorse or promote products derived from this software without specific prior written permission.

THIS SOFTWARE IS PROVIDED BY THE COPYRIGHT HOLDERS AND CONTRIBUTORS "AS IS" AND ANY EXPRESS OR IMPLIED WARRANTIES, INCLUDING, BUT NOT LIMITED TO, THE IMPLIED WARRANTIES OF MERCHANTABILITY AND FITNESS FOR A PARTICULAR PURPOSE ARE DISCLAIMED. IN NO EVENT SHALL THE COPYRIGHT HOLDER OR CONTRIBUTORS BE LIABLE FOR ANY DIRECT, INDIRECT, INCIDENTAL, SPECIAL, EXEMPLARY, OR CONSEQUENTIAL DAMAGES (INCLUDING, BUT NOT LIMITED TO, PROCUREMENT OF SUBSTITUTE GOODS OR SERVICES; LOSS OF USE, DATA, OR PROFITS; OR BUSINESS INTERRUPTION) HOWEVER CAUSED AND ON ANY THEORY OF LIABILITY, WHETHER IN CONTRACT, STRICT LIABILITY, OR TORT (INCLUDING NEGLIGENCE OR OTHERWISE) ARISING IN ANY WAY OUT OF THE USE OF THIS SOFTWARE, EVEN IF ADVISED OF THE POSSIBILITY OF SUCH DAMAGE.

## Other information

### Troubleshooting

If the CK does not behave as expected—for example, not producing the correct sound or producing no sound at all—you can try to resolve the issue as described below. Many issues can also be resolved by carrying out the *Factory Reset* (page 67) operation. If any specific issue should persist, please contact your Yamaha dealer or a service center (see the back of this booklet).

Issue	Suspected cause	Solution
The CK turns off unexpectedly.	This is normal when the <i>Auto Power Off</i> function is enabled.	If necessary, you can disable the <i>Auto Power Off</i> function to prevent it from turning off the CK again (page 36).
No sound is produced.	All the Part [ON/OFF] buttons are OFF.	Set the desired Part [ON/OFF] button to ON.
	The Part volume is turned fully down.	Use the Part Volume sliders to adjust the volume.
	<i>Local Control</i> is set to <i>Off</i> .	When <i>Local Control</i> is set to <i>Off</i> , the internal tone generator will not play a sound when you play the keyboard. Set <i>Local Control</i> to <i>On</i> (page 37).
	MIDI volume or expression has been set to a very low level by an external MIDI controller.	Try changing a Live Set Sound. If a pedal has been connected to the FOOT PEDAL jacks, move the pedal to change the volume.
No sound is produced from the built-in speakers.	SPEAKERS switch is set to OFF.	Set the SPEAKERS switch to ON.
	When the headphones are connected, the built-in speakers may be muted in certain settings as shown below. <ul style="list-style-type: none"> <li>When the [MENU] button → <i>General</i> → <i>System</i> → <i>Speaker</i> → <i>Speaker Mute</i> is set to <i>Auto</i>.</li> <li>When the [MENU] button → <i>General</i> → <i>System</i> → <i>Speaker</i> → <i>Speaker Mute</i> is set to <i>Manual</i> and the SPEAKERS switch is set to OFF.</li> </ul>	Disconnect the headphones.  Set the SPEAKERS switch to ON.
No sound is produced from the connected external device.	Power to the CK or the connected external audio device is not turned on.	Check the power to the CK and the connected external audio device is turned on.
	The volume of the CK and the connected external audio equipment are turned fully down.	Adjust the volume. Use the [MASTER VOLUME] slider to adjust the volume. If a pedal has been connected to the FOOT PEDAL jacks, try moving the pedals.
A sound continues to play indefinitely.	An Effect (such as delay) continues.	Lower the [DEPTH] knob or set the EFFECT1 or EFFECT2 [ON/OFF] button to OFF. If a Live Set Sound has been changed while a sound continues to play, try selecting a different Live Set Sound.
Sounds are distorted.	Effect settings are not appropriate.	Sound will be distorted depending on the effect types and the settings. Change the effect types and the settings.
	Volume is set too high. <i>Output Gain</i> is set too high.	Adjust the volume. To adjust the overall volume of the CK, move the [MASTER VOLUME] slider. Or, use the [MENU] button → <i>General</i> → <i>Audio</i> → <i>Output Gain</i> (page 38).



Issue	Suspected cause	Solution
Sounds are distorted.	The Volume of the connected external audio device is set too high.	Adjust the volume of the connected external audio device or use the A/D INPUT [GAIN] knob of the CK. Or, you can also adjust the volume from the [MENU] button → <i>General</i> → <i>Audio</i> → <i>USB Audio Volume</i> (page 38).
Sound output is intermittent and stutters.	The total number of notes has exceeded the maximum polyphony (128 notes).	Be careful not to exceed the maximum polyphony.
No effect is applied.	Effects are set to OFF.	Set the effects ON with the EFFECT 1 [ON/OFF] button or the EFFECT 2 [ON/OFF] button.
	The depth is turned to the minimum level.	Use the [DEPTH] knob to adjust the effect depth.
Moving the Pitch Bend Wheel or Modulation Wheel does not change the sound.	The value is set to "0."	Change the value.
Nothing is shown on the Display (LCD).	The [MENU] button → <i>General</i> → <i>Control Panel</i> → <i>Display</i> → <i>LCD Switch</i> is set to <i>Off</i> .	Make sure to set the [MENU] button → <i>General</i> → <i>Control Panel</i> → <i>Display</i> → <i>LCD Switch</i> to <i>On</i> (page 38).  If the menu items are not visible, adjust the contrast from the [MENU] button → <i>General</i> → <i>Control Panel</i> → <i>Display</i> → <i>LCD Contrast</i> (page 38).
A pedal does not work.	The pedal type is not correct.	Set from the [MENU] button → <i>General</i> → <i>Foot Pedal</i> → <i>Pedal 1</i> or <i>Pedal 2</i> (page 39).
	The pedal is not correctly connected.	Make sure that the pedal's plug is fully and firmly inserted.
	<i>Receive SW</i> is turned off.	From the [SETTINGS] button → <i>Controllers</i> → <i>Receive SW</i> , select a pedal and set it to ON (page 31).
Cannot save files to the external USB flash drive.	The USB flash drive is write-protected.	Disable the write protection.
	The USB flash drive is not formatted properly.	Format the USB flash drive again.
Communication between the computer and the CK does not work properly.	The Port settings on the computer are not appropriate.	Check the port settings on the computer.
MIDI bulk data transmission does not work properly.	Use of the wrong terminals (MIDI or USB).	Check the settings.
	Wrong MIDI device number.	Check the MIDI device number.

## Restoring the Factory Default Settings (*Factory Reset*)

The *Factory Reset* function allows you to restore the CK to its initial condition.

### NOTICE

When the *Factory Reset* function is carried out, all the Live Set Sounds you have stored, as well as the settings of MENU screens and SETTINGS screens will be overwritten with their defaults. It is wise, therefore, to regularly save backups of important settings on a USB flash drive.

### ■ Carrying out the *Factory Reset*

To reset all values to the factory defaults, press the [MENU] button → *Job* → *Factory Reset* (page 40).

## Display messages

Messages	Description
Auto power off disabled.	This message appears when <i>Auto Power Off</i> is disabled.
Bluetooth pairing...Press [EXIT] button to cancel pairing.	The Bluetooth device and the CK are being paired. Press the [EXIT] button to cancel pairing.
Change [Pedal Live Set Inc/Dec] to [Off].	Before changing the foot pedal assignment from the [SETTINGS] button, you need to set the <i>Live Set Inc/Dec</i> parameter to <i>off</i> from the [MENU] button.
Completed.	The specified operation (Load, Save, Format or another Job) has been completed.
Connect a USB device.	There is no connected USB device.
Connecting to USB device...	Currently recognizing the USB flash drive connected to the USB [TO DEVICE] terminal.
Device number is off.	Bulk data cannot be transmitted or received because the device number is off.
Device number mismatch.	Bulk data cannot be received because the device numbers do not match.
File or folder already exists.	A file or a folder having the same name as the one you are about to save already exists.
File or folder path is too long.	The file or folder cannot be accessed because the maximum length for the file name or the pathname has been exceeded.
Illegal bulk data.	An error occurred while receiving a Bulk data or Bulk Request message.
Illegal file name.	The specified file name is invalid. Try entering a different name.
Illegal file.	The specified file is unusable by the CK or cannot be loaded.
Incompatible USB device.	A USB device that cannot be used with the CK has been connected to the USB [TO DEVICE] terminal.
Low Battery!	The batteries are low. Replace the batteries.
MIDI buffer full.	Failed to process the MIDI data because too much data was received at one time.
MIDI checksum error.	An error occurred when receiving bulk data.
No read/write authority to the file.	Indicates that you do not have the authority to read or write to the file.
Now receiving MIDI bulk data...	Indicates the CK is receiving MIDI bulk data.
Now transmitting MIDI bulk data...	Indicates the CK is transmitting MIDI bulk data.
Please reboot to maintain internal memory.	Reboot the CK to restore the internal memory.
Press both [ENTER]+[MENU] buttons.	Press the [ENTER] button and the [MENU] button simultaneously to disable the panel lock.
Speaker EQ is set to [Table].	<i>Speaker EQ</i> has been set to <i>Table</i> .
Split Point does not exist.	Cannot change the <i>Split Point</i> because it has not been set.
Unsupported USB device.	This message appears when the connected USB flash drive is either unformatted, or formatted in a way that the CK does not support. Please format the USB flash drive using the CK.
USB connection terminated.	Communication with the USB flash drive has been shut down due to overcurrent to the USB flash drive. Disconnect the USB flash drive from the USB [TO DEVICE] terminal, and then reboot the CK.
USB device is full.	The USB flash drive is full and no more data can be saved. Use a new USB flash drive, or make space by erasing unwanted data from the USB flash drive.
USB device is write-protected.	This message appears when you have attempted to write to a protected USB flash drive.
USB device read/write error.	An error occurred while reading from or writing to a USB flash drive.

## Specifications

Item		Details		
		CK88	CK61	
Keyboard	Type	GHS keyboard: matte black keytops	FSB keyboard, initial touch	
	Number of Keys	88	61	
Tone Generation	Tone Generation Technology	AWM2, AWM (Organ Flutes)		
	Polyphony (max.)	128		
Voices	Number of Live Set Sounds	160 (Preset Live Set Sounds: 80)		
	Number of Voices	363		
	Effects	Insertion Effect	Drive 1 system (5 types) Effect 2 systems (1: 36 types, 2: 36 types)	
		Delay	4 types	
		Reverb	3 types	
Master EQ		3-band		
Display	Type	Full Dot LCD (128 × 64 dots)		
Connectivity		OUTPUT [L/MONO]/[R] (6.3 mm, standard phone jacks, unbalanced) A/D INPUT [L/MONO]/[R] (6.3 mm, standard phone jacks) [PHONES] (6.3 mm, standard stereo phone jack) FOOT PEDAL [1]/[2] MIDI [IN]/[OUT] USB [TO HOST]/[TO DEVICE] [DC IN]		
Bluetooth (May not have this functionality depending on the country in which you purchased the product.)	Bluetooth version	4.1		
	Supported profile	A2DP		
	Compatible codec	SBC		
	Wireless output	Bluetooth class 2		
	Maximum communication distance	about 10 m		
	Radio Frequency (Operational Frequency)	2401–2481 MHz		
	Maximum output power (EIRP)	4 dBm		
	Type of modulation	FHSS		
USB audio interface	Sampling Frequency	44.1 kHz		
	Channels	In: 2 channels (1 stereo channel) Out: 2 channels (1 stereo channel)		
Sound System	Amplifiers	6 W × 2		
	Speakers	(12 cm × 6 cm) × 2, Switchable ON/OFF		
Power Supply	Power Supply	AC adaptor	PA-150B or an equivalent recommended by Yamaha (Output: DC 12V, 1.5 A)	
		Batteries	Eight "AA" size alkaline (LR6) or Ni-MH rechargeable batteries	
	Power Consumption	11 W (When using PA-150B AC adaptor)		
Size/Weight	Dimensions (W × D × H)	1333 mm × 354 mm × 148 mm (52-1/2 inch × 13-15/16 inch × 5-13/16 inch)	910 mm × 291 mm × 109 mm (35-13/16 inch × 11-7/16 inch × 4-5/16 inch)	
	Weight	13.1 kg (28 lb 14 oz) (not including batteries)	5.6 kg (12 lb 6 oz) (not including batteries)	
Included Accessories		AC adaptor*, Owner's Manual *May be included depending on your locale		

The contents of this manual apply to the latest specifications as of the publishing date. To obtain the latest manual, access the Yamaha website then download the manual file. Since specifications, equipment or separately sold accessories may not be the same in every locale, please check with your Yamaha dealer.

# Index

## Symbols

.wav ..... 25  
 .wav See also *audio file*

## A

audio file ..... 19, 25, 32  
 Audio Trigger ..... 12, 24

## B

Backup ..... 27  
 Bluetooth pairing ..... 46  
 built-in speakers ..... 36

## E

Edit Recall ..... 25, 40  
 External Keyboard ..... 32

## F

Factory default. See also *Factory Reset*  
 Factory Reset ..... 40, 67  
 File type ..... 27  
 Foot Controller ..... 18, 31, 37  
 Foot Pedal ..... 18

## I

Initialize  
     factory reset ..... 67  
     Live Set Sound ..... 26  
     MENU ..... 40

## L

Live Set Overview ..... 9  
 Load  
     Backup File ..... 27, 41

## M

Master Keyboard ..... 24, 33  
 Master Tune ..... 36  
 Mic input ..... 25, 38  
 Modulation ..... 10, 29, 31, 37

## N

Note Shift ..... 29

## P

Panel lock ..... 24, 38, 42  
 Portamento ..... 14, 28

## S

Save  
     saving settings to a USB flash drive ..... 27  
     saving settings to the CK. See also *Store*  
 Speaker EQ ..... 36  
 Speakers  
     built-in speakers ..... 18  
 Store ..... 14, 24  
 Sustain ..... 18, 31

## T

Touch Sensitivity ..... 29, 30

## U

USB Audio ..... 31, 38  
 USB MIDI ..... 19

## Y

Yamaha Steinberg USB Driver ..... 47



**Important Notice:  
U.S. LIMITED WARRANTY for Customers in the United States**

For detailed information about this Yamaha product and warranty service, please either visit the following website address (printable file is available at our website) or contact Customer Service at the address or telephone number identified below.

**Website Address:**

[Yamaha.io/SynthAndStageWarranty](http://Yamaha.io/SynthAndStageWarranty)

**Customer Service:**

Yamaha Corporation of America  
6600 Orangethorpe Avenue, Buena Park, CA 90620-1273  
Telephone: 800-854-1569

# Important Notice: Guarantee Information for customers in European Economic Area (EEA) and Switzerland

<b>Important Notice: Guarantee Information for customers in EEA* and Switzerland</b> For detailed guarantee information about this Yamaha product, and Pan-EEA* and Switzerland warranty service, please either visit the website address below (Printable file is available at our website) or contact the Yamaha representative office for your country. * EEA: European Economic Area	<b>English</b>
<b>Wichtiger Hinweis: Garantie-Information für Kunden in der EWR* und der Schweiz</b> Für nähere Garantie-Information über dieses Produkt von Yamaha, sowie über den Pan-EWR*- und Schweizer Garantieservice, besuchen Sie bitte entweder die folgend angegebene Internetadresse (eine druckfähige Version befindet sich auch auf unserer Webseite), oder wenden Sie sich an den für Ihr Land zuständigen Yamaha-Vertrieb. *EWR: Europäischer Wirtschaftsraum	<b>Deutsch</b>
<b>Remarque importante: informations de garantie pour les clients de l'EEE et la Suisse</b> Pour des informations plus détaillées sur la garantie de ce produit Yamaha et sur le service de garantie applicable dans l'ensemble de l'EEE ainsi qu'en Suisse, consultez notre site Web à l'adresse ci-dessous (le fichier imprimable est disponible sur notre site Web) ou contactez directement Yamaha dans votre pays de résidence. * EEE : Espace Economique Européen	<b>Français</b>
<b>Belangrijke mededeling: Garantie-informatie voor klanten in de EER* en Zwitserland</b> Voor gedetailleerde garantie-informatie over dit Yamaha-product en de garantieservice in heel de EER* en Zwitserland, gaat u naar de onderstaande website (u vindt een afdrukbaar bestand op onze website) of neemt u contact op met de vertegenwoordiging van Yamaha in uw land. * EER: Europese Economische Ruimte	<b>Nederlands</b>
<b>Aviso importante: información sobre la garantía para los clientes del EEE* y Suiza</b> Para una información detallada sobre este producto Yamaha y sobre el soporte de garantía en la zona EEE* y Suiza, visite la dirección web que se incluye más abajo (la versión del archivo para imprimir esta disponible en nuestro sitio web) o póngase en contacto con el representante de Yamaha en su país. * EEE: Espacio Económico Europeo	<b>Español</b>
<b>Avviso importante: informazioni sulla garanzia per i clienti residenti nell'EEA* e in Svizzera</b> Per informazioni dettagliate sulla garanzia relativa a questo prodotto Yamaha e l'assistenza in garanzia nei paesi EEA* e in Svizzera, potete consultare il sito Web all'indirizzo riportato di seguito (è disponibile il file in formato stampabile) oppure contattare l'ufficio di rappresentanza locale della Yamaha. * EEA: Area Economica Europea	<b>Italiano</b>
<b>Aviso importante: informações sobre as garantias para clientes da AEE* e da Suíça</b> Para obter uma informação pormenorizada sobre este produto da Yamaha e sobre o serviço de garantia na AEE* e na Suíça, visite o site a seguir (o arquivo para impressão está disponível no nosso site) ou entre em contato com o escritório de representação da Yamaha no seu país. * AEE: Área Económica Europeia	<b>Português</b>
<b>Σημαντική σημείωση: Πληροφορίες εγγύησης για τους πελάτες στον ΕΟΧ* και Ελλάδα</b> Για λεπτομερείς πληροφορίες εγγύησης σχετικά με το παρόν προϊόν της Yamaha και την κάλυψη εγγύησης σε όλες τις χώρες του ΕΟΧ και την Ελλάδα, επισκεφτείτε την παρακάτω ιστοσελίδα (Εκτυπίσιμη μορφή είναι διαθέσιμη στην ιστοσελίδα μας) ή απευθυνθείτε στην αντιπροσωπεία της Yamaha στη χώρα σας. * ΕΟΧ: Ευρωπαϊκός Οικονομικός Χώρος	<b>Ελληνικά</b>
<b>Viktigt: Garantiinformation för kunder i EES-området* och Schweiz</b> För detaljerad information om denna Yamahaprodukt samt garantiservice i hela EES-området* och Schweiz kan du antingen besöka nedanstående webbadress (en utskriftsvänlig fil finns på webbplatsen) eller kontakta Yamahas officiella representant i ditt land. * EES: Europeiska Ekonomiska Samarbetsområdet	<b>Svenska</b>
<b>Viktig merknad: Garantiinformasjon for kunder i EØS* og Sveits</b> Detaljert garantiinformasjon om dette Yamaha-produktet og garantiservice for hele EØS-området* og Sveits kan fås enten ved å besøke nettstedene nedenfor (utskriftsversjon finnes på våre nettsider) eller kontakte Yamahas kontoret i landet der du bor. *EØS: Det europeiske økonomiske samarbeidsområdet	<b>Norsk</b>
<b>Vigtig oplysning: Garantioplysninger til kunder i EØ* og Schweiz</b> De kan finde detaljerede garantioplysninger om dette Yamaha-produkt og den fælles garantiserviceordning for EØ* (og Schweiz) ved at besøge det websted, der er angivet nedenfor (der findes en fil, som kan udskrives, på vores websted), eller ved at kontakte Yamahas nationale repræsentationskontor i det land, hvor De bor. * EØ: Det Europæiske Økonomiske Område	<b>Dansk</b>
<b>Tärkeä ilmoitus: Takuutiedot Euroopan talousalueen (ETA)* ja Sveitsin asiakkaille</b> Tämän Yamaha-tuotteen sekä ETA-alueen ja Sveitsin takuuta koskevat yksityiskohtaiset tiedot saatte alla olevasta nettiosoitteesta. (Tulostettava tiedosto saatavissa sivustollamme.) Voititte myös ottaa yhteyttä paikalliseen Yamaha-edustajaan. *ETA: Euroopan talousalue	<b>Suomi</b>
<b>Ważne: Warunki gwarancyjne obowiązujące w EOG* i Szwajcarii</b> Aby dowiedzieć się więcej na temat warunków gwarancyjnych tego produktu firmy Yamaha i serwisu gwarancyjnego w całym EOG* i Szwajcarii, należy odwiedzić wskazaną poniżej stronę internetową (Plik gotowy do wydruku znajduje się na naszej stronie internetowej) lub skontaktować się z przedstawicielstwem firmy Yamaha w swoim kraju. * EOG — Europejski Obszar Gospodarczy	<b>Polski</b>
<b>Důležité oznámení: Záruční informace pro zákazníky v EHS* a ve Švýcarsku</b> Podrobné záruční informace o tomto produktu Yamaha a záručním servisu v celém EHS* a ve Švýcarsku naleznete na níže uvedené webové adrese (soubor k tisku je dostupný na našich webových stránkách) nebo se můžete obrátit na zastoupení firmy Yamaha ve své zemi. * EHS: Evropský hospodářský prostor	<b>Česky</b>
<b>Fontos figyelemzetés: Garancia-információk az EGT* területén és Svájcban élő vásárlók számára</b> A jelen Yamaha termékre vonatkozó részletes garancia-információk, valamint az EGT*-re és Svájcra kiterjedő garanciális szolgáltatás tekintetében keresse fel webhelyünket az alábbi címen (a webhelyen nyomtatható fájl is található), vagy pedig lépjen kapcsolatba az országában működő Yamaha képviselői irodával. * EGT: Európai Gazdasági Térség	<b>Magyar</b>
<b>Oluline märkus: Garantiiteave Euroopa Majanduspiirkonna (EMP)* ja Šveitsi klientidele</b> Täpsemat teabe saamiseks selle Yamaha toote garantii ning kogu Euroopa Majanduspiirkonna ja Šveitsi garantiiteeninduse kohta, külastage palun veebisaiti alljärgneval aadressil (meie saidil on saadaval printitav fail) või pöörduge Teie regiooni Yamaha esinduse poole. * EMP: Euroopa Majanduspiirkond	<b>Eesti keel</b>
<b>Svarīgs paziņojums: garantijas informācija klientiem EEZ* un Šveicē</b> Lai saņemtu detalizētu garantijas informāciju par šo Yamaha produktu, kā arī garantijas apkalpošanu EEZ* un Šveicē, lūdzmu, apmeklējiet zemāk norādīto tīmekļa vietnes adresi (tīmekļa vietnē ir pieejams drukājams fails) vai sazinieties ar jūsu valsti apkalpojošo Yamaha pārstāvniecību. * EEZ: Eiropas Ekonomikas zona	<b>Latviešu</b>
<b>Dėmesio: informacija dėl garantijos pirkėjams EEE* ir Šveicarijoje</b> Jei reikia išsamios informacijos apie šį „Yamaha“ produktą ir jo techninę priežiūrą visoje EEE* ir Šveicarijoje, apsilankykite mūsų svetainėje toliau nurodytu adresu (svetainėje yra spausdintinas failas) arba kreipkitės į „Yamaha“ atstovybę savo šaliai. *EEE – Europos ekonominė erdvė	<b>Lietuvių kalba</b>
<b>Dôležité upozornenie: Informácie o záruke pre zákazníkov v EHP* a Švajčiarsku</b> Podrobné informácie o záruke týkajúce sa tohto produktu od spoločnosti Yamaha a garančnom servise v EHP* a Švajčiarsku nájdete na webovej stránke uvedenej nižšie (na našej webovej stránke je k dispozícii súbor na tlač) alebo sa obráťte na zástupcu spoločnosti Yamaha vo svojej krajine. * EHP: Európsky hospodársky priestor	<b>Slovenčina</b>
<b>Pomembno obvestilo: Informacije o garanciji za kupce v EGP* in Švici</b> Za podrobnejše informacije o tem Yamahinem izdelku ter garancijskem servisu v celotnem EGP in Švici, obiščite spletno mesto, ki je navedeno spodaj (natisljiva datoteka je na voljo na našem spletnem mestu), ali se obrnite na Yamahinega predstavnika v svoji državi. * EGP: Evropski gospodarski prostor	<b>Slovenščina</b>
<b>Важно съобщение: Информация за гаранцията за клиенти в ЕИП* и Швейцария</b> За подробна информация за гаранцията за този продукт на Yamaha и гаранционното обслужване в паневропейската зона на ЕИП* и Швейцария или посетете посочения по-долу уеб сайт (на нашия уеб сайт има файл за печат), или се свържете с представителния офис на Yamaha във вашата страна. * ЕИП: Европейско икономическо пространство	<b>Български език</b>
<b>Notificare importantă: Informații despre garanție pentru clienții din SEE* și Elveția</b> Pentru informații detaliate privind acest produs Yamaha și serviciul de garanție Pan-SEE* și Elveția, vizitați site-ul la adresa de mai jos (fișierul imprimabil este disponibil pe site-ul nostru) sau contactați biroul reprezentanței Yamaha din țara dumneavoastră. * SEE: Spațiul Economic European	<b>Limba română</b>
<b>Važna obavijest: Informacije o jamstvu za države EGP-a i Švicarske</b> Za detaljne informacije o jamstvu za ovaj Yamahin proizvod te jamstvenom servisu za cijeli EGP i Švicarsku, molimo Vas da posjetite web-stranicu navedenu u nastavku ili kontaktirate ovlaštenog Yamahinog dobavljača u svojoj zemlji. * EGP: Evropski gospodarski prostor	<b>Hrvatski</b>

<https://europe.yamaha.com/warranty/>

For details of products, please contact your nearest Yamaha representative or the authorized distributor listed below.

Pour plus de détails sur les produits, veuillez-vous adresser à Yamaha ou au distributeur le plus proche de vous figurant dans la liste suivante.

Die Einzelheiten zu Produkten sind bei Ihrer unten aufgeführten Niederlassung und bei Yamaha Vertragshändlern in den jeweiligen Bestimmungsländern erhältlich.

Para detalles sobre productos, contacte su tienda Yamaha más cercana o el distribuidor autorizado que se lista debajo.

## NORTH AMERICA

### CANADA

**Yamaha Canada Music Ltd.**  
135 Milner Avenue, Toronto, Ontario M1S 3R1,  
Canada  
Tel: +1-416-298-1311

### U.S.A.

**Yamaha Corporation of America**  
6600 Orangethorpe Avenue, Buena Park, CA 90620,  
U.S.A.  
Tel: +1-714-522-9011

## CENTRAL & SOUTH AMERICA

### MEXICO

**Yamaha de México, S.A. de C.V.**  
Av. Insurgentes Sur 1647 Piso 9, Col. San José  
Insurgentes, Delegación Benito Juárez, CDMX,  
C.P. 03900, México  
Tel: +52-55-5804-0600

### BRAZIL

**Yamaha Musical do Brasil Ltda.**  
Praça Professor José Lannes, 40-Cjs 21 e 22, Brooklin  
Paulista Novo CEP 04571-100 – São Paulo – SP,  
Brazil  
Tel: +55-11-3704-1377

### ARGENTINA

**Yamaha Music Latin America, S.A.,  
Sucursal Argentina**  
Olga Cossettini 1553, Piso 4 Norte,  
Madero Este-C1107CEK,  
Buenos Aires, Argentina  
Tel: +54-11-4119-7000

### PANAMA AND OTHER LATIN

### AMERICAN REGIONS/ CARIBBEAN REGIONS

**Yamaha Music Latin America, S.A.**  
Edificio Torre Davivienda, Piso: 20  
Avenida Balboa, Marbella, Corregimiento de Bella  
Vista, Ciudad de Panamá, Rep. de Panamá  
Tel: +507-269-5311

## EUROPE

### THE UNITED KINGDOM/IRELAND

**Yamaha Music Europe GmbH (UK)**  
Sherbourne Drive, Tilbrook, Milton Keynes,  
MK7 8BL, U.K.  
Tel: +44-1908-366700

### GERMANY

**Yamaha Music Europe GmbH**  
Siemensstrasse 22-34, 25462 Rellingen, Germany  
Tel: +49-4101-303-0

### SWITZERLAND/LIECHTENSTEIN

**Yamaha Music Europe GmbH, Branch  
Switzerland in Thalwil**  
Seestrasse 18a, 8800 Thalwil, Switzerland  
Tel: +41-44-3878080

### AUSTRIA/CROATIA/CZECH REPUBLIC/ HUNGARY/ROMANIA/SLOVAKIA/ SLOVENIA

**Yamaha Music Europe GmbH, Branch Austria**  
Schleiergasse 20, 1100 Wien, Austria  
Tel: +43-1-60203900

### POLAND

**Yamaha Music Europe  
Sp.z o.o. Oddział w Polsce**  
ul. Wielicka 52, 02-657 Warszawa, Poland  
Tel: +48-22-880-08-88

### BULGARIA

**Dinacord Bulgaria LTD.**  
Bul. Iskarsko Schose 7 Targowski Zentar Ewropa  
1528 Sofia, Bulgaria  
Tel: +359-2-978-20-25

### MALTA

**Olimpus Music Ltd.**  
Valletta Road, Mosta MST9010, Malta  
Tel: +356-2133-2093

### NETHERLANDS/BELGIUM/ LUXEMBOURG

**Yamaha Music Europe, Branch Benelux**  
Clarissenhof 5b, 4133 AB Vianen, The Netherlands  
Tel: +31-347-358040

### FRANCE

**Yamaha Music Europe**  
7 rue Ambroise Croizat, Zone d'activités de Pariest,  
77183 Croissy-Beaubourg, France  
Tel: +33-1-6461-4000

### ITALY

**Yamaha Music Europe GmbH, Branch Italy**  
Via Tinelli N.67/69 20855 Gerno di Lesmo (MB),  
Italy  
Tel: +39-039-9065-1

### SPAIN/PORTUGAL

**Yamaha Music Europe GmbH Ibérica, Sucursal  
en España**  
Ctra. de la Coruña km. 17,200, 28231  
Las Rozas de Madrid, Spain  
Tel: +34-91-639-88-88

### GREECE

**Philippos Nakas S.A. The Music House**  
19th km. Leof. Lavriou 190 02 Peania – Attiki,  
Greece  
Tel: +30-210-6686260

### SWEDEN

**Yamaha Music Europe GmbH Germany Filial  
Scandinavia**  
JA Wettergrensgata 1, 400 43 Göteborg, Sweden  
Tel: +46-31-89-34-00

### DENMARK

**Yamaha Music Denmark,  
Filial of Yamaha Music Europe GmbH, Tyskland**  
Generatorvej 8C, ST. TH., 2860 Søborg, Denmark  
Tel: +45-44-92-49-00

### FINLAND

**F-Musiikki Oy**  
Antaksentie 4  
FI-01510 Vantaa, Finland  
Tel: +358 (0)96185111

### NORWAY

**Yamaha Music Europe GmbH Germany -  
Norwegian Branch**  
Grini Næringspark 1, 1332 Østerås, Norway  
Tel: +47-6716-7800

### ICELAND

**Hljóðfaerahúsid Ehf.**  
Sidumula 20  
IS-108 Reykjavik, Iceland  
Tel: +354-525-5050

### CYPRUS

**Nakas Music Cyprus Ltd.**  
Nikis Ave 2k  
1086 Nicosia  
Tel: + 357-22-511080  
**Major Music Center**  
21 Ali Riza Ave. Ortakoy  
P.O.Box 475 Lefkoşa, Cyprus  
Tel: (392) 227 9213

### RUSSIA

**Yamaha Music (Russia) LLC.**  
Room 37, entrance 7, bld. 7, Kievskaya street,  
Moscow, 121059, Russia  
Tel: +7-495-626-5005

### OTHER EUROPEAN REGIONS

**Yamaha Music Europe GmbH**  
Siemensstrasse 22-34, 25462 Rellingen, Germany  
Tel: +49-4101-303-0

## AFRICA

**Yamaha Music Gulf FZE**  
JAFZA-16, Office 512, P.O.Box 17328,  
Jebel Ali FZE, Dubai, UAE  
Tel: +971-4-801-1500

## MIDDLE EAST

### TURKEY

**Yamaha Music Europe GmbH  
Merkezi Almanya Türkiye İstanbul Şubesi**  
Mor Sumbul Sokak Varyap Meridian Business  
1.Blok No:1 113-114-115  
Bati Atasehir İstanbul, Turkey  
Tel: +90-216-275-7960

### ISRAEL

**RBX International Co., Ltd.**  
P.O Box 10245, Petach-Tikva, 49002  
Tel: (972) 3-925-6900

### OTHER REGIONS

**Yamaha Music Gulf FZE**  
JAFZA-16, Office 512, P.O.Box 17328,  
Jebel Ali FZE, Dubai, UAE  
Tel: +971-4-801-1500

## ASIA

### THE PEOPLE'S REPUBLIC OF CHINA

**Yamaha Music & Electronics (China) Co., Ltd.**  
2F, Yunhedasha, 1818 Xinzha-lu, Jingan-qu,  
Shanghai, China  
Tel: +86-400-051-7700

### HONG KONG

**Tom Lee Music Co., Ltd.**  
11/F., Silvercord Tower 1, 30 Canton Road,  
Tsimshatsui, Kowloon, Hong Kong  
Tel: +852-2737-7688

### INDIA

**Yamaha Music India Private Limited**  
P-401, JMD Megapolis, Sector-48, Sohna Road,  
Gurugram-122018, Haryana, India  
Tel: +91-124-485-3300

### INDONESIA

**PT Yamaha Musik Indonesia Distributor**  
Yamaha Music Center Bldg. Jalan Jend. Gatot  
Subroto Kav. 4, Jakarta 12930, Indonesia  
Tel: +62-21-520-2577

### KOREA

**Yamaha Music Korea Ltd.**  
11F, Prudential Tower, 298, Gangnam-daero,  
Gangnam-gu, Seoul, 06253, Korea  
Tel: +82-2-3467-3300

### MALAYSIA

**Yamaha Music (Malaysia) Sdn. Bhd.**  
No.8, Jalan Perbandaran, Kelana Jaya, 47301  
Petaling Jaya, Selangor, Malaysia  
Tel: +60-3-78030900

### SINGAPORE

**Yamaha Music (Asia) Private Limited**  
Block 202 Hougang Street 21, #02-00,  
Singapore 530202, Singapore  
Tel: +65-6740-9200

### TAIWAN

**Yamaha Music & Electronics Taiwan Co., Ltd.**  
2F., No.1, Yuandong Rd., Banqiao Dist.,  
New Taipei City 22063, Taiwan (R.O.C.)  
Tel: +886-2-7741-8888

### THAILAND

**Siam Music Yamaha Co., Ltd.**  
3, 4, 15, 16th Fl., Siam Motors Building,  
891/1 Rama 1 Road, Wangmai,  
Pathumwan, Bangkok 10330, Thailand  
Tel: +66-2215-2622

### VIETNAM

**Yamaha Music Vietnam Company Limited**  
15th Floor, Nam A Bank Tower, 201-203 Cach  
Mang Thang Tam St., Ward 4, Dist.3,  
Ho Chi Minh City, Vietnam  
Tel: +84-28-3818-1122

### OTHER ASIAN REGIONS

[https://asia-latinamerica-mea.yamaha.com/  
index.html](https://asia-latinamerica-mea.yamaha.com/index.html)

## OCEANIA

### AUSTRALIA

**Yamaha Music Australia Pty. Ltd.**  
Level 1, 80 Market Street, South Melbourne,  
VIC 3205 Australia  
Tel: +61-3-9693-5111

### NEW ZEALAND

**Music Works LTD**  
P.O.BOX 6246 Wellesley, Auckland 4680,  
New Zealand  
Tel: +64-9-634-0099

### REGIONS AND TRUST TERRITORIES IN PACIFIC OCEAN

[https://asia-latinamerica-mea.yamaha.com/  
index.html](https://asia-latinamerica-mea.yamaha.com/index.html)



Manual Development Group  
© 2022 Yamaha Corporation

Published 06/2022 MWMA-B0

YAMAHA CORPORATION

10-1 Nakazawa-cho, Naka-ku, Hamamatsu, 430-8650 Japan

VGD1900