

**MOOER**

**VEM BoX**

Vocal Multi-Effects Processor

**Owner's Manual**

# Contents

Precautions .....	02
Items Explanation .....	03
Main Features .....	04
Battery Operation .....	04
Panel Instruction .....	05
Connections .....	07
Operation .....	08
Patch Selecting .....	08
Expression Pedal .....	09
Patch Editing .....	11
Patch Storing/Copying .....	13
Patch Pre-Select Recall Function .....	14
Vocoder Function .....	15
Loop Function .....	16
Factory Reset .....	18
Effects Explanation .....	19
Specification .....	24
Troubleshooting .....	25
Appendix .....	25
Patch List .....	26

# Precautions

**\* PLEASE READ CAREFULLY BEFORE PROCEEDING \***

## **Power Supply**

Please connect the designated AC adapter to an AC outlet of the correct voltage.

Please be sure to use only an AC adapter which supplies 9V DC, 300 mA, center minus.

Unplug the AC power adapter when not using or during electrical storms.

## **Connections**

Always turn off the power of this and all other equipments before connecting or disconnecting, this will help prevent malfunction and / or damage to other devices. Also make sure to disconnect all connection cables and the power cord before moving this unit.

## **Location**

To avoid deformation, discoloration, or other serious damage, do not expose this unit to the following conditions:

- Direct sunlight
- Heat sources
- Magnetic fields
- Extreme temperature or humidity
- Excessive dusty or dirty location
- High humidity or moisture
- Strong vibration or shock

## **Interference with other electrical devices**

Radios and televisions placed nearby may experience reception interference. Operate this unit at a suitable distance from radios and televisions.

## **Cleaning**

Clean only with a soft, dry cloth. If necessary, slightly moisten the cloth. Do not use abrasive cleanser, cleaning alcohol, paint thinners, wax, solvents, cleaning fluids, or chemical-impregnated wiping cloths.

## **Handling**

Do not apply excessive force to the switches or controls.

Do not let paper, metallic, or other objects into this unit.

Take care not to drop the unit, and do not subject it to shock or excessive pressure.

# Items Explanation

## **Patch**

A patch is comprised of information about the on/off status and effect parameter settings used in each module.

## **Bank**

A bank is a group of ten patches. VEM Box has 7 banks, labelled with numbers 0 to 3 (unchangeable preset banks) and letters A to d (editable user banks).

## **Effect module**

A patch can be thought of as a combination of up to 8 single effects. Each such effect is referred to as an effect module.

## **Effect type**

Some effect modules have several different effects which are referred to as effect types. Only one of these can be selected at a time.

## **Effect parameter**

All effect modules have various parameters that can be adjusted. These are called effect parameters or simply parameters. When thinking of an effect module as a compact effect, the parameters change the tone and effect intensity similar to the knobs on the device.

## **Mode**

Mode is the status of different function of keys and controls, VEM Box has Patch Mode for selecting and using patches, Loop Mode for recording loop phrase, Edit Mode for modifying effects, and Store Mode for saving patches.

# Main Features

- 8 Effect Modules & 54 Effect Types
- 40 Preset Patches & 40 User Patches
- Phrase Looper with 16 seconds of recording time
- Vocoder Function
- Assignable Expression Pedal
- Patch Pre-Select function
- Compact operation interface
- Lightweight and tiny for easy transportation
- AC adapter 9V DC power supply
- AA/LR6 battery (x4) power supply

## Battery Operation

1. Turn off the VEM Box and open the battery holder on the bottom.
2. Insert 4 AA/LR6 batteries and close the battery holder.

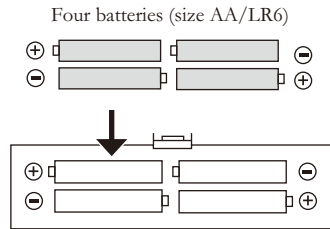
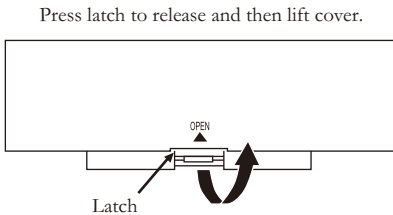

**Note:** When the batteries are getting low, the display will show  to indicate this situation.

**Note:** When using batteries, it is suggested to disconnect the microphone cable plug from the [MIC IN] jack when not using the device, to conserve battery power.

# Panel Instruction

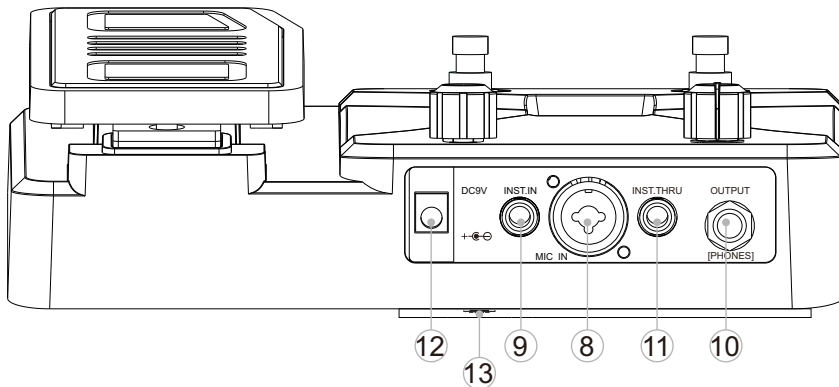
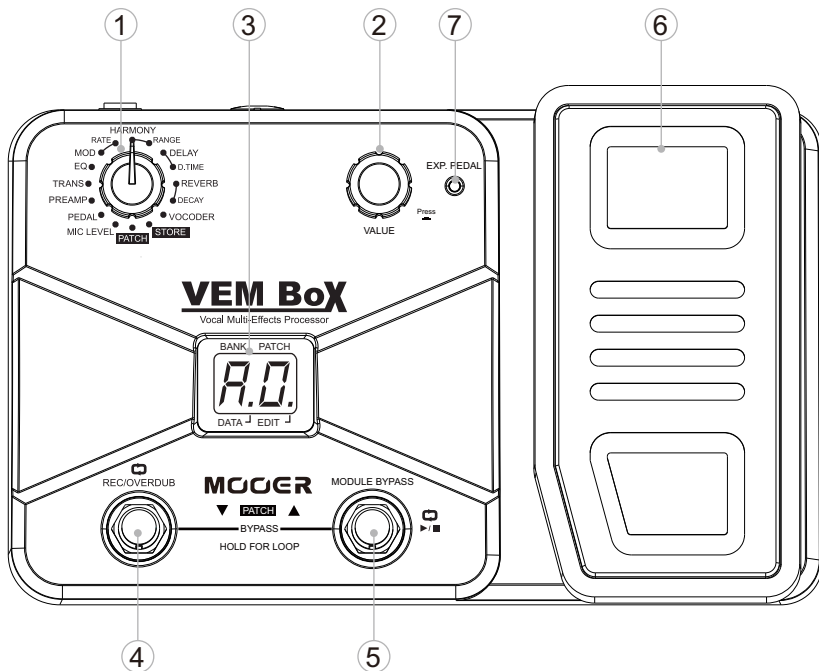

- 01 Module Selector:** Switches between every function module. In patch edit mode, this knob selects the module/parameter for operation.
- 02 VALUE Knob with Enter Button:** Dial the knob for setting master level, or changing parameter values. Press the button to switch effect type, ensure storing, etc.
- 03 LED Display:** Shows bank and patch numbers, setting values, and other information for operating.
- 04 PATCH - [REC/OVERDUB] Footswitch:** Selects patches (backwards), start loop recording/overdubbing, and other functions.
- 05 PATCH + [MODULE BYPASS] Footswitch:** Selects patches (forwards), play/stop loop, bypass effect module, and other functions.
- 06 Expression Pedal:** Adjusts volume or some effect parameters.
- 07 EXP. PEDAL LED:** Indicates the status of the expression pedal.
- 08 MIC IN Jack:** XLR + 1/4" TRS audio jack, for connecting microphone. When operating VEM Box on batteries, plugging Mic cable into this jack will turn on the unit.
- 09 INST. IN Jack:** 1/4" mono audio jack, for connecting guitar or other instruments.
- 10 OUTPUT [PHONES] Jack:** 1/4" stereo audio jack, for connecting headphone or amplifier. Using a mono cable can output the signal to an amplifier, or use a Y cable to output the signal to two amplifiers. Also can plug a stereo headphone into this jack.
- 11 INST. THRU Jack:** 1/4" mono audio jack, output the signal directly from INST.IN jack.
- 12 DC 9V Jack:** For power supply, use a 9-volt DC regulated by AC adapter, 300mA (plug polarity is positive on the barrel and negative in the center).
- 13 Battery Holder:** For installing batteries (AA/LR6 x 4).

# Connections

AC adapter

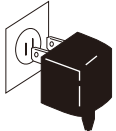

Microphone

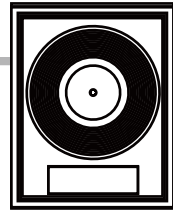
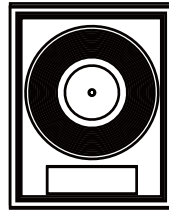

Amplifiers

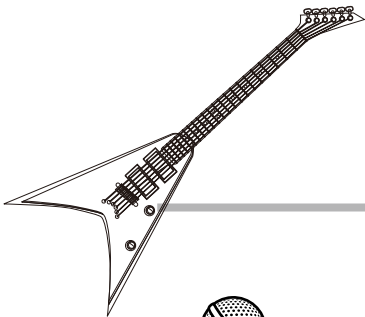
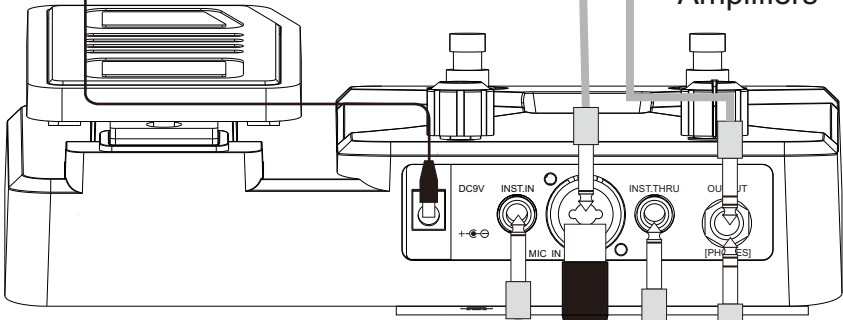

Microphone



Headphones

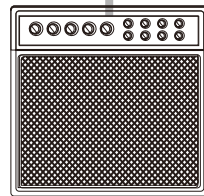

Guitar amplifier



# Operation

## Patch Selecting

### 01 Power On

Plug the cable of AC Adapter (9V, 300mA, center minus) into the [DC 9V] Jack, when using batteries, plug the Mic cable into [MIC IN] this jack will turn the device on.

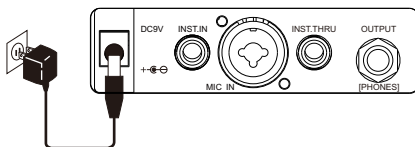

### 02 Selecting Patches

Set the Module Selector to [PATCH], the LED display will show the information of bank and patch number, step on [PATCH +/-] footswitch to change patches (Hold one footswitch to switch patches quickly).

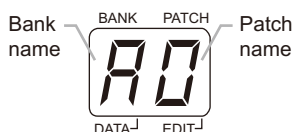

Pressing [PATCH +] footswitch time and again (or holding [PATCH +] footswitch) cycles through patches in the order 00~09 ... 40~49, 00~09... 30~39, 00 Pressing or holding [PATCH -] footswitch will switch patches in the opposite order.

### 03 Adjusting the master volume

Set the Module Selector to [PATCH], rotate [VALUE] knob to adjust the master volume of VEM Box (when setting up the master volume, LED display will show the current level). The range of master volume is 00~99, 70 is the default value.



### 04 Entering Bypass Mode

When in PATCH mode, press both [PATCH -] and [PATCH +] footswitches together to enter bypass mode. LED will display 6P, and all of the effects will be turned off.

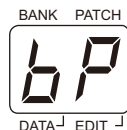

# Expression Pedal

## 01 Volume Control

If the [EXP. PEDAL] LED is not lighted up, the expression pedal will be a volume pedal for controlling the master level of VEM Box.

## 02 Effect Control

If the [EXP. PEDAL] LED is lighted up, the expression pedal will be an expression pedal for controlling the effect's parameter which was set up in PEDAL setting.

## 03 Control Assign

Set the Module Selector to [PEDAL], the LED display will show the controlling object of the expression pedal.

There are 9 kinds of parameter can be controlled by the pedal, LED will show the type of parameter in control:

Control Target	LED Display	Control Parameter
Wah	$\text{WR}$	Central Frequency
Transducer	$\text{TR}$	Gain / Cutoff
Modulation Rate	$\text{MR}$	Rate / Frequency
Modulation Depth	$\text{MD}$	Depth
Harmony Range	$\text{HR}$	Pitch
Delay Time	$\text{DT}$	Time
Delay Feedback	$\text{DF}$	Feedback
Reverb Level	$\text{RL}$	Reverb Level
Vocoder Gender	$\text{UG}$	Gender

Rotate [VALUE] knob to choose one kind of controlling target, then the expression pedal will work with the corresponding parameter.

**Note:** There will be a symbol  $\Rightarrow$  behind the effect parameter which can be controlled by the pedal (refer to Effect Explanation for detail).

**Note:** If the effect module of the chosen target was not turned on, the pedal will be of no effect.

**Note:** Pedal setting can be stored in patch.

**Note:** The expression pedal will be effective in EDIT mode.



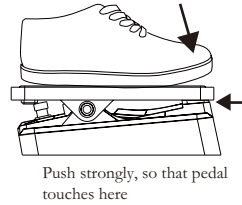

## 04 Switch Control Mode (Volume-Effect)

Push down the expression pedal at full tilt to switch the control mode from volume control to effect control, and [EXP.PEDAL] LED will shift from extinguish to light. It also can switch the control mode from effect control to volume control, [EXP.PEDAL] LED will shift from light to extinguish.



## 05 Pedal Reset

The responsiveness of the expression pedal on VEM Box can be reset as necessary. If the effect change seems insufficient when pushing the pedal down, or if the volume or tone changes excessively even when the pedal is only lightly pushed, or if it's hard to switch the pedal mode, adjust the pedal as follows:

- a. Set the Module Selector to [PEDAL] and hold down [VALUE] button and then power on, the indication  will appear on the LED display, and then release the [VALUE] button.
- b. Fully raise the expression pedal and press [VALUE] button once, the indication  will appear on the LED display.
- c. Push the expression pedal fully down and press [VALUE] button again, the indication  will appear on the LED display.
- d. Push strongly down the expression pedal at full tilt and press [VALUE] button once more. The Pedal Reset adjustment is completed, and VEM Box will return to the play mode. If the indication  is shown, press [VALUE] button and repeat the procedure from step b.

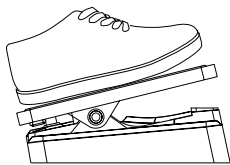

Fully raise

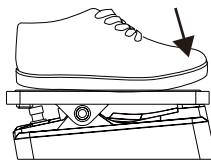

Fully down

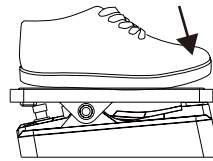

Push strongly, so that pedal touches here

# Patch Editing

## 01 Select Effect Module

Set the Module Selector to the effect module which you want to edit, the available setting options are listed below:

- 01.MIC LEVEL (Para)
- 02.PEDAL (Para)
- 03.PREAMP (Type & Para)
- 04.TRANS (Type & Para)
- 05.EQ (Type & Para)
- 06.MOD (Type & Para)
- 07.RATE (Para)
- 08.HARMONY (Type)
- 09.RANGE (Para)
- 10.DELAY (Type & Para)
- 11.D.TIME (Para)
- 12.REVERB (Type & Para)
- 13.DECAY (Para)
- 14.VOCODER (Type & Para)

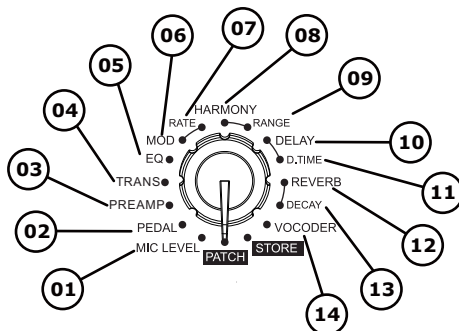

**Type & Para:** The effect type (left side of the display) and parameter's value (right side of the display) are adjusted simultaneously.

**Type:** Only select the effect type.

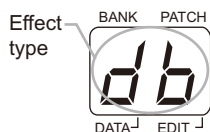

**Para:** Only adjust the parameter's value.

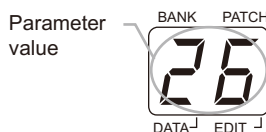

In fact, the RATE module is a part of MOD module, the RANGE module is a part of HARMONY module, the D.TIME module is a part of DELAY module, and the DECAY module is a part of REVERB module. They are all parameter's value setting module which belongs to the previous effect module.

## 02 Change Setting

Press [VALUE] knob to change effect/parameter type ahead, hold and rotate [VALUE] knob to change effect/parameter type ahead (clockwise) or backwards (anticlockwise), rotate [VALUE] knob to set a new value of the effect type or parameter. As long as the selected item's value changes, a dot (•) will appear in the bottom right of the display. This indicates that a setting has been changed from the currently stored value.

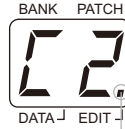
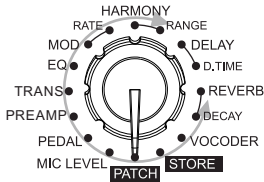

Dot indicates that setting has been changed



## 03 Bypass an Effect Module

When adjusting an effect in EDIT mode, press [MODULE BYPASS] / [PATCH +] footswitch to bypass this effect module, the indication  will appear on the display and the module will be turned off. Pressing [MODULE BYPASS] / [PATCH +] switches once more will return the setting to the previous condition.

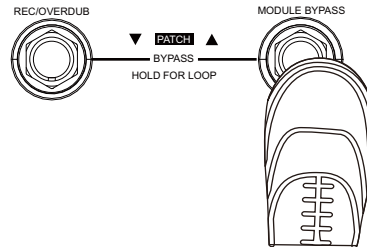
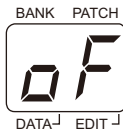

## 04 Adjusting the MIC LEVEL

Set the Module Selector to [MIC LEVEL], rotate [VALUE] knob to adjust the volume of a patch, LED display will show the current level.

The range of patch level is  ~ .

*Note: If you return to [PATCH] module and select another patch, the changes you have made in edit mode will be lost unless you store the patch first.*

# Patch Storing/Copying

## 01 Enter Storing Mode

Set the Module Selector to [STORE] to enter storing mode, the display will show the current editing patch's number.



## 02 Storing/Copying Patch

When in [STORE] mode, press [VALUE] button once to do the storing, the patch's number on the display will begin to flash, at that time, rotate [VALUE] knob or press [PATCH -] / [PATCH +] footswitch to change patch number, when you got the expectant position, press [VALUE] button again to confirm the patch storing, the patch's number on the display will stop flashing.



*Note: To cancel the store process, rotate the Module Selector to another position, well then the patch will not be saved.*

*Note: An edited patch can be stored in a user bank (A~d), it can not be stored in a preset patch (0~3).*

*Note: Storing an existing patch in another location can create a copy.*

# Patch Pre-Select Recall Function

Patch Pre-Select function can let you select the patch first but not to activate it, and then perform an additional step to activate the patch.

To use this function, conform to the following instructions:

- 01 Before power on, hold down the [PATCH +] footswitch, and then power to the VEM Box, **P5** will appear on the display and last flashing for 3 seconds, it indicates setting up to Patch Pre-Select function successfully.

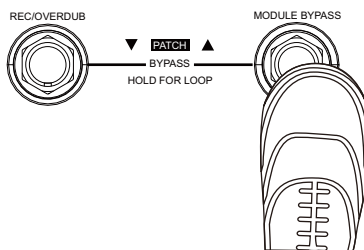

- 02 In PATCH mode, select the patch to use next. The selected new bank and patch's number flash on the display, but the sound does not change yet.



- 03 Press both [PATCH -] and [PATCH +] footswitches together, the selected patch will be activated, the sound changes, and the display will stop flashing.

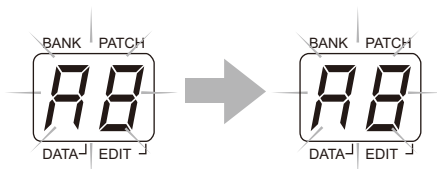
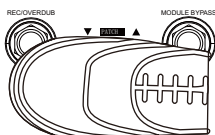

- 04 To return the normal patch selecting method, turn the power off and then on again. The Patch Pre-Select function will not preserve when power on again.

# Vocoder Functions

Vocoder is a process of using real-time frequency spectrum of one sound (Modulator) to modulate the frequency spectrum of another (Carrier). It contains a series of bandpass filters that allow through only those frequencies detected in the Modulator source. For example, when a human voice is used to modulate a synthesizer voice, it will sound like the synthesizer is talking, very interesting effects.

## 01 Selecting Vocoder Types

Set the Module Selector to [VOCODER] to enter Vocoder module, you can select vocoder types by pressing [VALUE] button. There are 3 types of vocoder effects in VEM Box: Vocoder, Robot, Whisper.

**Vocoder** is a standard classical vocoder, you need to plug an instrument into the INST. IN jack as a carrier source, and connect your microphone to [MIC IN] jack, then play the instrument while speaking or singing, you will enjoy the wonder sound.

**Robot** is a traditional vocoder effect often heard from many sci-fi movies, to use this vocoder effect, just plug your mic and speak or sing.

**Whisper** is an alternative vocoder effect which can make your voice sound like devil speaking, to use this vocoder effect, just plug your mic and speak or sing.

## 02 Adjusting Vocoder Effects

Each vocoder effect has the same parameter (Gender) to adjust, use [VALUE] knob to change parameter range (1~9), gender can slew the pitch of the vocoder down for a more masculine sound (smaller value) or up for a more feminine sound (bigger value).

***Note:** When Vocoder module is working, other effects module will be invalid, but the parameters of them will be unchanged.*

***Note:** When saving a patch with active vocoder effects, other module's parameter can be stored as well whereas they are invalid. When vocoder is set to off in this patch, other effects modules will return to their corresponding state.*



# Loop Functions

## 01 Enter Loop Mode

Hold down [PATCH -] and [PATCH +] footswitches together longer than 2 seconds to enter Loop mode, LED display will show .

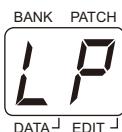

## 02 Loop Recording

When in Loop mode, press [PATCH-] / [REC/OVERDUB] footswitch once to start recording,  will appear on the LED display and last flashing.



During first time recording, press [PATCH-] / [REC/OVERDUB] footswitch again to set the loop end, recording will be stopped and turn to loop playback; press [PATCH+] footswitch can also set the loop end but the loop will be stopped.

**Note:** The maximum recording time is 16 seconds, the loop end will be set immediately once the first recording time goes beyond 16 seconds.

**Note:** Only the MIC IN signal can be recorded.

## 03 Overdub

When a loop is already recorded, no matter it is stopped or in playback, press [PATCH-] / [REC/OVERDUB] footswitch to start overdubbing,  will flash on the LED display again.

During overdubbing, press [patch-] / [REC/OVERDUB] footswitch will stop overdubbing and turn to playback, then press [patch-] / [REC/OVERDUB] footswitch again will do another overdubbing.



You can record a loop and overdub it again and again, there is no limit of overdubbing times.

**Note:** Once the overdubbing time goes beyond the loop length, a new overdubbing will begin automatically from the loop start.

## 04 Delete Loop

If VEM Box has a recorded loop data, a dot (.) will appear in the middle bottom of LED display. Hold down VALUE button longer than 3 seconds while the loop is in the stop status, the loop data will be deleted and the dot (.) will disappear as well.



### 05 Play/Stop loop

When loop is at stop status (LED display shows  $\square P$ ), press [PATCH+] footswitch to start loop playing (if there is no loop data, playback can not be executed).

When the loop is playing ( $\square L$  is flashing on the LED display), press [PATCH+] footswitch to stop playback, LED display will show  $\square P$ .

When recording ( $\square L$  is flashing on the LED display), press [PATCH+] footswitch to stop playing and recording, LED display will turn to show  $\square P$ , press [PATCH+] footswitch again to start playback.

### 06 Exit Loop mode

When in Loop mode, hold down [PATCH -] and [PATCH +] footswitches together longer than 2 seconds to exit loop function.

### 07 Selecting effects and Patch in Loop mode

When in Loop mode, you can select patches and adjust effects as well. Set the Module Selector to [PATCH] module, you can select patches by rotating [VALUE] knob. When adjusting effects in loop mode, the parameters's value shown in LED display will last flashing, moreover, the LED will return to indicate loop function if there is no operation in 3 seconds.

*Note: The loop data will be remain even though you exit the loop mode, it will be lost after power off or deleting operation.*

*Note: When selecting patches or adjusting effects in Loop mode, any operation of Loop function will turned the LED display to indicate loop information at once.*

*Note: In Loop mode, store function can not be operated.*

# Factory Reset

Factory Reset function will initialize all setting of VEM Box. All the user patches will be erased and overwritten by the preset patches. To do the factory reset, conform to the following instructions:

Before power on, set the Module Selector to [PATCH], hold down the [PATCH -] and [PATCH +] footswitch and the [VALUE] button simultaneously, and then power to the VEM Box, **FS** will appear on the display and last flashing.

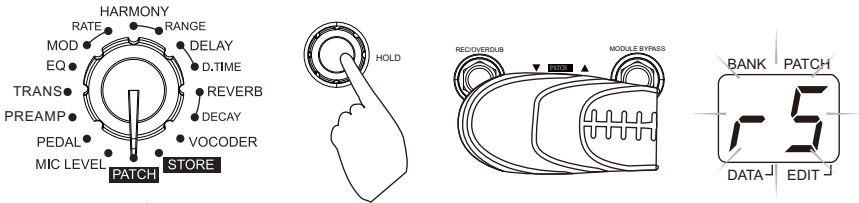

At that time, press [VALUE] button to confirm, **FS** will be flashing in a faster speed for 2 seconds, then turn to display **FS** at a steady status for 3 second, then back to the normal state, the factory reset operation have been done.

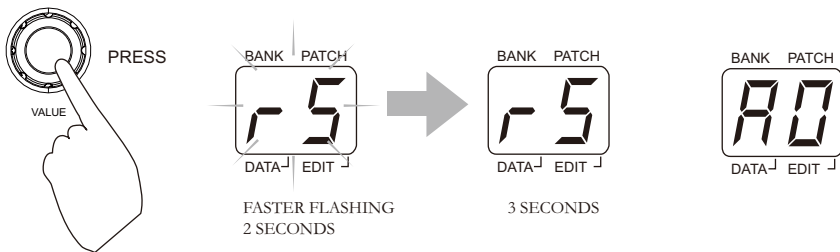

**Note:** If you want to quit Factory Reset halfway, move the Module Selector to another location, then the Factory Reset will be canceled.

# Effects Explanation

## 01 General Instruction

### Effect Chain

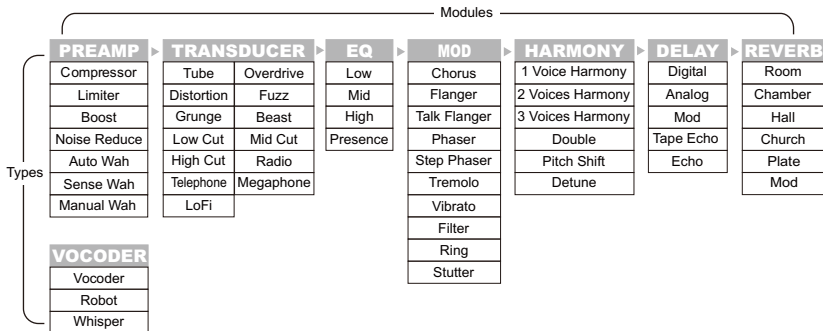



VEM Box has 8 effect modules, 54 types of effect in total, can offer up to 7 simultaneous effects (VOCODER module can not work with any other module at one time).

Each effect module has several different effect types, only one type can be selected at a time. All effect types have various parameters that can be adjusted, the parameters change the tone and effect intensity similar to the knobs on the device.

## 02 Explain the Effects Modules/Types/Parameters











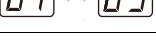
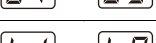

### PREAMP Module

Type Name	Display	Effect Explanation
Compressor		This effect is used for controlling dynamics of the signal, it limits high-level signals and boosts low-level signals. The parameter's value controls the <b>Depth</b> .
Limiter		This effect limits high-level signals to avoid overload. The parameter's value controls the <b>Depth</b> .
Boost		This effect can enhance the gain and dynamic of the signal. The parameter's value controls the <b>Gain</b> .
NR		Noise Reduction, it will reduce the noise of input signal. The parameter's value controls the NR's <b>Intensity</b> .
Auto Wah		This effect creates a recurrent wah-wah sound. The parameter's value controls the <b>Rate</b> .

Sense Wah		This effect varies wah sound according to input intensity. The parameter's value controls the <b>Sensitivity</b> .
Manual Wah ➤		This effect varies wah sound by turning the knob or controlling the expression pedal. The parameter's value controls the <b>Central Frequency</b> .

➤ This mark means the parameter can be controlled by the expression pedal if corresponding type was chosen in PEDAL module.

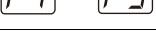
## TRANS (Transducer) Module

Type Name	Display	Effect Explanation
Tube ➤		This effect simulates a warm tube drive tone of classical tube preamplifier. The parameter's value controls the <b>Gain</b> .
Overdrive ➤		This effect produces a natural overdrive sound. The parameter's value controls the <b>Gain</b> .
Distortion ➤		This effect creates a smooth distortion sound. The parameter's value controls the <b>Gain</b> .
Fuzz ➤		This effect creates a classic fuzz sound. The parameter's value controls the <b>Gain</b> .
Grunge ➤		This effect creates a dirty but powerful distortion sound. The parameter's value controls the <b>Gain</b> .
Beast ➤		This effect makes your voice offensive like a beast. The parameter's value controls the <b>Gain</b> .
Low Cut ➤		This effect cuts the low frequency. The parameter's value controls the <b>Cutoff</b> .
Mid Cut ➤		This effect cuts the mid frequency. The parameter's value controls the <b>Cutoff</b> .
High Cut ➤		This effect cuts the high frequency. The parameter's value controls the <b>Cutoff</b> .
Radio ➤		This effect sounds like coming from an old radio. The parameter's value controls the <b>Cutoff</b> .
Telephone ➤		This effect sounds like coming from a telephone. The parameter's value controls the <b>Cutoff</b> .
Megaphone ➤		This effect sounds like coming from a megaphone. The parameter's value controls the <b>Cutoff</b> .
LoFi ➤		This effect creates a rough lofi sound. The parameter's value controls the <b>Cutoff</b> .

## EQ (Equalizer) Module

Type Name	Display	Effect Explanation
Low		This controls the bottom band of the equalizer, the central frequency is 200Hz. The parameters value controls the <b>Gain</b> .
Mid		This controls the middle band of the equalizer, the central frequency is 500Hz. The parameters value controls the <b>Gain</b> .
High		This controls the high band of the equalizer, the central frequency is 1kHz. The parameters value controls the <b>Gain</b> .
Presence		This controls the ultra high band of the equalizer, the central frequency is 8kHz. The parameter 's value controls the <b>Gain</b> .

### EQ Gain-Display Comparison:

Para-Display	1	2	3	4	5	6	7	8	9
Gain	-12dB	-9dB	-6dB	-3dB	0dB	+3dB	+6dB	+9dB	+12dB

## MOD (Modulation) Module

Type Name	Display	Effect Explanation
Chorus ➤		This effect creates a shining dimensional sound. The parameter's value controls the <b>Depth</b> .
Flanger ➤		This effect produces an undulating and floating feeling sound. The parameter's value controls the <b>Depth</b> .
Talk Flanger ➤		This effect produces another kind of flanger sound. The parameter's value controls the <b>Depth</b> .
Phaser ➤		This effect creates a pulsing-like sound. The parameter's value controls the <b>Depth</b> .
Step Phaser ➤		This effect produces a phaser sound with more pulsing feeling. The parameter's value controls the <b>Depth</b> .
Tremolo ➤		This effect periodically influences the volume of the signal. The parameter's value controls the <b>Depth</b> .
Vibrato ➤		This effect periodically influences the pitch of the signal. The parameter's value controls the <b>Depth</b> .
Filter ➤		This effect produces a sweeping filter sound. The parameter's value controls the <b>Depth</b> .
Ring ➤		Produces sounds like ring bell. The parameter's value controls the <b>Effect's Level</b> .
Stutter ➤		This effect makes your sound on and off. The parameter's value controls the <b>Depth</b> .
Rate ➤		Control the speed of effects, except Ring.
Frequency ➤		Control the frequency when use Ring.

**HARMONY Module**

Type Name	Display	Effect Explanation
1 Voice Harmony		This effect transfers the pitch and blend with the original note.
2 Voices Harmony		This effect creates 2 pitch shift sound blended with the original note.
3 Voices Harmony		This effect creates 3 pitch shift sound blended with the original note
Double		This effect makes your voice thicker and wider.
Pitch Shift		This effect transfers the original note's pitch.
Detune		This effect slightly shifts the pitch and mixes it back with the original signal to create a chorus-like effect.

**HARMONY Range Comparison:**

Type Name	Display	Effect Explanation
1 Voice Harmony		Control the harmony range from -12 semitones to +12 semitones.
2 Voices Harmony		Each parameter corresponds to a 2 Voices Harmony sound, conform to the following list.
3 Voices Harmony		Each parameter corresponds to a 3 Voices Harmony sound, conform to the following list.
Double		Control the doubling effects' depth.
Pitch Shift		Control the pitch range from -12 semitones to +12 semitones.
Detune		Control the pitch range from 1 cent to 30 cents.

2 Voices Harmony (semitone)		3 Voices Harmony (semitone)	
	-12, +12		-12, -7, -4
	-7, -12		-12, -7, +12
	-7, -4		-12, -5, +12
	-7, +4		-12, +5, +12
	-7, +7		-12, +7, +12
	-4, +4		-7, -4, +4
	-4, +7		-7, -4, +7
	+4, +7		-7, +4, +7
	+5, +12		-4, +4, +7
	+7, +12		+4, +7, +12

**DELAY Module**

Type Name	Display	Effect Explanation
Digital ➤		Repeat the signal with no special processing, creates the most clean delay sound. The parameter's value controls the <b>Feedback</b> .
Analog ➤		Simulates an analog delay equipment, produces a warm and vintage delay sound. The parameter's value controls the <b>Feedback</b> .
Mod ➤		Adds chorus effect to the delay sound, has more extensive spacy feeling. The parameter's value controls the <b>Feedback</b> .
Tape Echo ➤		Simulates an Tape Echo machine, creates a tape-like delay sound. The parameter's value controls the <b>Feedback</b> .
Echo ➤		Simulates the real Echo, authentic and natural delay sound. The parameter's value controls the <b>Feedback</b> .
Delay Time ➤		The value indicates the delay time from 10ms~1500ms.

**REVERB Module**

Type Name	Display	Effect Explanation
Room ➤		Simulates the acoustics of a Room. The parameter's value controls the Reverb's <b>Level</b> .
Chamber ➤		Simulates the acoustics of a Chamber. The parameter's value controls the Reverb's <b>Level</b> .
Hall ➤		Simulates the acoustics of a concert Hall. The parameter's value controls the Reverb's <b>Level</b> .
Church ➤		Simulates the acoustics of a big church. The parameter's value controls the Reverb's <b>Level</b> .
Plate ➤		Simulates a Plate reverberation. The parameter's value controls the Reverb's <b>Level</b> .
Mod ➤		Add Chorus effect to a Hall reverb. The parameter's value controls the Reverb's <b>Level</b> .
Decay		Control the Decay of Reverb effect

**VOCODER Module**

Type Name	Display	Effect Explanation
Vocoder		Offers a wonderful vocoder effect, like the guitar sound (keyboard, synthesizer, or other instruments) is talking. The parameter's value controls the Vocoder's <b>Gender</b> .
Robot		This effect can make your voice sound like a robot. The parameter's value controls the Vocoder's <b>Gender</b> .
Whisper		This effect can make your voice sound like devil speaking. The parameter's value controls the Vocoder's <b>Gender</b> .

**Note:** The Vocoder effect must work with instruments input, or else there is no sound, the Robot effect and Whisper effect didn't have to.



# Specification

<b>No. of Effect Modules:</b>	8 Modules (Max. 7 simultaneous modules)
<b>No. of Effect Types:</b>	54 Types
<b>Preset Patch Memory:</b>	40 Patches (4 Banks, each bank has 10 patches)
<b>User Patch Memory:</b>	40 Patches (4 Banks, each bank has 10 patches)
<b>MIC IN Jack:</b>	XLR+1/4" TRS audio jack
<b>INST. IN Jack:</b>	1/4" mono audio jack
<b>OUTPUT [PHONES] Jack:</b>	1/4" stereo audio jack(doubles as line/headphone jack)
<b>INST. THRU Jack:</b>	1/4" mono audio jack
<b>Power requirements:</b>	AC adapter 9V DC, 300 mA (center minus plug) or 4 AA/LR6 batteries
<b>Dimensions:</b>	158mm (D) x 237mm (W) x 63mm (H)
<b>Weight:</b>	750g (without batteries)
<b>Accessories:</b>	Owner's Manual, AC adapter 9V DC

*\* Disclaimer: Any specification's update won't be amended in this manual.*

# Troubleshooting

## **Can not power on**

Check power connection.

----- Make sure the power is connected correctly.

Check the adapter.

----- Make sure the adapter's type is DC9V/300mA/center minus.

When using battery, check whether the cable is inserted entirely to the MIC IN jack.

When using battery, check the battery, is the battery low or dead?

----- Make sure the battery is at work and the MIC IN jack is connected with an audio cable.

## **No sound or low volume**

Check connection of cables.

----- Make sure all the cables are connected firmly.

Check the on/off switch of microphone and the volume setting of amplifier.

----- Make sure each equipment's volume is set to an appropriate level.

## **High noise**

Check the adapter.

----- Make sure the adapter's type is DC9V/300mA/center minus.

Check the cables.

----- Make sure the cables are connected firmly and have no quality problem.

# Appendix

## Patch List

Patch	Patch Name	Reverb Level	Patch	Patch Name	Pedal Assign
<i>R0</i>	Simple Repeat	Volume	<i>E0</i>	Tape Echo	Volume
<i>R1</i>	Bright Hall	Reverb Level	<i>E1</i>	3-Voice Plate	Volume
<i>R2</i>	FB Plate	Volume	<i>E2</i>	Double	Volume
<i>R3</i>	Dirty Thing	Volume	<i>E3</i>	Telephone	Volume
<i>R4</i>	4th Down	Volume	<i>E4</i>	Naughty Child	Volume
<i>R5</i>	Radio	Volume	<i>E5</i>	Holy Water	Reverb Level
<i>R6</i>	Choir	Volume	<i>E6</i>	5th Up	Volume
<i>R7</i>	Ghost Vib	Vibrato Depth	<i>E7</i>	Dark Hall	Reverb Level
<i>R8</i>	Evil Voice	Harmony Range	<i>E8</i>	Breathe	Volume
<i>R9</i>	Classic Vocoder	Volume	<i>E9</i>	Devil Inside	Vocoder Gender
<i>b0</i>	Beast Speak	Volume	<i>d0</i>	Chorus Echo	Volume
<i>b1</i>	Comp Echo	Volume	<i>d1</i>	Detune	Volume
<i>b2</i>	Nice 2-Voice	Volume	<i>d2</i>	4th Wah	Volume
<i>b3</i>	Chop Chop	Stutter Rate	<i>d3</i>	Spacy	Reverb Level
<i>b4</i>	Lofi Harmony	Volume	<i>d4</i>	Fuzzy Boy	Fuzz Gain
<i>b5</i>	Top On Tower	Volume	<i>d5</i>	Fast Echo	Delay Feedback
<i>b6</i>	Little Jet	Flanger Rate	<i>d6</i>	Broken Mirror	Volume
<i>b7</i>	Underwater	Flanger Rate	<i>d7</i>	Scary Movie	Reverb Level
<i>b8</i>	Infiniteness	Volume	<i>d8</i>	Snow Man	Volume
<i>b9</i>	Reform	Vocoder Gender	<i>d9</i>	Robot	Vocoder Gender

**MOOER**

---

MOOER AUDIO CO.,LTD  
Shenzhen, China  
[www.mooeraudio.com](http://www.mooeraudio.com)