

*It's Green Thinking*

# DMX-4 LED

## User Manual

INPUT VOLTAGE EQUALS OUTPUT VOLTAGE  
OUTPUT: 5 A / CH; 15 A MAX

**CHAUVET®**  
Value • Innovation • Performance

MODE	MENU	DISPLAY	DESCRIPTION
DMX Mode	Address	R001-R512	
	Personality	CH-01	1 CHANNEL
		CH-02	2 CHANNEL
		CH-04	4 CHANNEL
	Switch/Dimmer	S1	CHANNEL 1 FUNCTION
Dimmer	o1	CHANNEL 2 FUNCTION	
	oF	CHANNEL 4 FUNCTION	
Standalone Mode	Program	P-01-P-16	
	Run Speed	SP-01-SP-99	SLOW - FAST
	Dimmer	d001-d100	0% - 100%

**DMX-4 LED**  
DIMMER / SWITCH PACK



# TABLE OF CONTENTS

<b>1. BEFORE YOU BEGIN</b> .....	<b>3</b>
WHAT IS INCLUDED .....	3
UNPACKING INSTRUCTIONS .....	3
MANUAL CONVENTIONS .....	3
ICONS .....	3
SAFETY INSTRUCTIONS .....	4
<b>2. INTRODUCTION</b> .....	<b>5</b>
PRODUCT OVERVIEW.....	5
<b>3. SETUP</b> .....	<b>6</b>
AC POWER.....	6
NOTES ON "SWITCH" OPERATION .....	6
CHANGING BETWEEN "DIMMER" AND "SWITCH" .....	6
MOUNTING.....	7
Orientation.....	7
Rigging.....	7
Rigging.....	8
<b>4. OPERATING INSTRUCTIONS</b> .....	<b>9</b>
CONFIGURING THE STARTING ADDRESS .....	9
DMX MODE.....	9
STANDALONE MODE .....	9
MENU MAP .....	9
DMX CHANNEL VALUES .....	10
4-Channel Personality.....	10
2-Channel Personality.....	10
1-Channel Personality.....	10
<b>5. APPENDIX</b> .....	<b>11</b>
GENERAL TROUBLESHOOTING .....	11
DMX PRIMER .....	12
FIXTURE LINKING (DAISY CHAIN) .....	12
DATA CABLING.....	12
DMX Data Cable.....	12
CABLE CONNECTORS .....	13
SETTING THE STARTING ADDRESS .....	13
3-Pin to 5-Pin Conversion Chart.....	14
Setting up a DMX Daisy Chain .....	14
GENERAL MAINTENANCE.....	15
RETURNS PROCEDURE .....	15
CLAIMS .....	15
<b>TECHNICAL SPECIFICATIONS</b> .....	<b>16</b>
<b>CONTACT US</b> .....	<b>16</b>

CHAUVET®, 2010, All Rights Reserved

Information and specifications in this User Manual are subject to change without notice.

CHAUVET® assumes no responsibility or liability for any errors or inaccuracies that may appear in this manual.

**Author: Anthony Chiappone**

**Revision: 01**

**Release Date: 12-10-2010**

# 1. BEFORE YOU BEGIN

## What is included

- 1 x DMX-4 LED
- 1 x Power Cord
- 1 x Warranty Card
- 1 x User Manual

## Unpacking Instructions

Immediately upon receiving a fixture, carefully unpack the carton, check the contents to ensure that all parts are present, and have been received in good condition. Notify the shipper immediately and retain packing material for inspection if any parts appear damaged from shipping or the carton itself shows signs of mishandling. Save the carton and all packing materials. In the event that a fixture must be returned to the factory, it is important that the fixture be returned in the original factory box and packing.



## Manual Conventions

CHAUVET® manuals use the following conventions to differentiate certain types of information from the regular text.

CONVENTION	MEANING
[10]	A DIP switch to be configured
<Menu>	A key to be pressed on the fixture's control panel
1~512	A range of values
50/60	A set of values of which only one can be chosen
<b>Settings</b>	A menu option not to be modified (for example, showing the operating mode/current status)
<b>MENU &gt; Settings</b>	A sequence of menu options to be followed
<b>ON</b>	A value to be entered or selected

## Icons

This manual uses the following icons to indicate information that requires special attention on the part of the user.

ICONS	MEANING
	This paragraph contains critical installation, configuration or operation information. Failure to comply with this information may render the fixture partially or completely inoperative, cause damage to the fixture or cause harm to the user.
	This paragraph contains important installation or configuration information. Failure to comply with this information may prevent the fixture from functioning correctly.
	This paragraph reminds you of useful, although not critical, information.

## Safety Instructions



Please read these instructions carefully. It includes important information about the installation, usage and maintenance of this product.

- Please keep this User Manual for future consultation. If you sell the unit to another user, be sure that they also receive this instruction booklet.
- Always make sure that you are connecting to the proper voltage, and that the line voltage you are connecting to is not higher than that stated on the decal or rear panel of the fixture.
- This product is intended for indoor use only! To prevent risk of fire or shock, do not expose fixture to rain or moisture.
- Make sure there are no flammable materials close to the unit while operating.
- The unit must be installed in a location with adequate ventilation, at least 20 in (50 cm) from adjacent surfaces. Be sure that no ventilation slots are blocked.
- Always disconnect from power source before servicing or replacing fuse and be sure to replace with same fuse source.
- Secure fixture to fastening device using a safety chain.
- Maximum ambient temperature (Ta) is 104° F (40° C). Do not operate fixture at temperatures higher than this.
- In the event of a serious operating problem, stop using the unit immediately. Never try to repair the unit by yourself. Repairs carried out by unskilled people can lead to damage or malfunction. Please contact the nearest authorized technical assistance center.
- Never connect the device to a dimmer pack.
- Make sure the power cord is never crimped or damaged.
- Never disconnect the power cord by pulling or tugging on the cord.
- Never carry the fixture directly from the cord. Always use the hanging/mounting bracket.
- Avoid direct eye exposure to the light source while it is on.

# 2. INTRODUCTION

## Product Overview

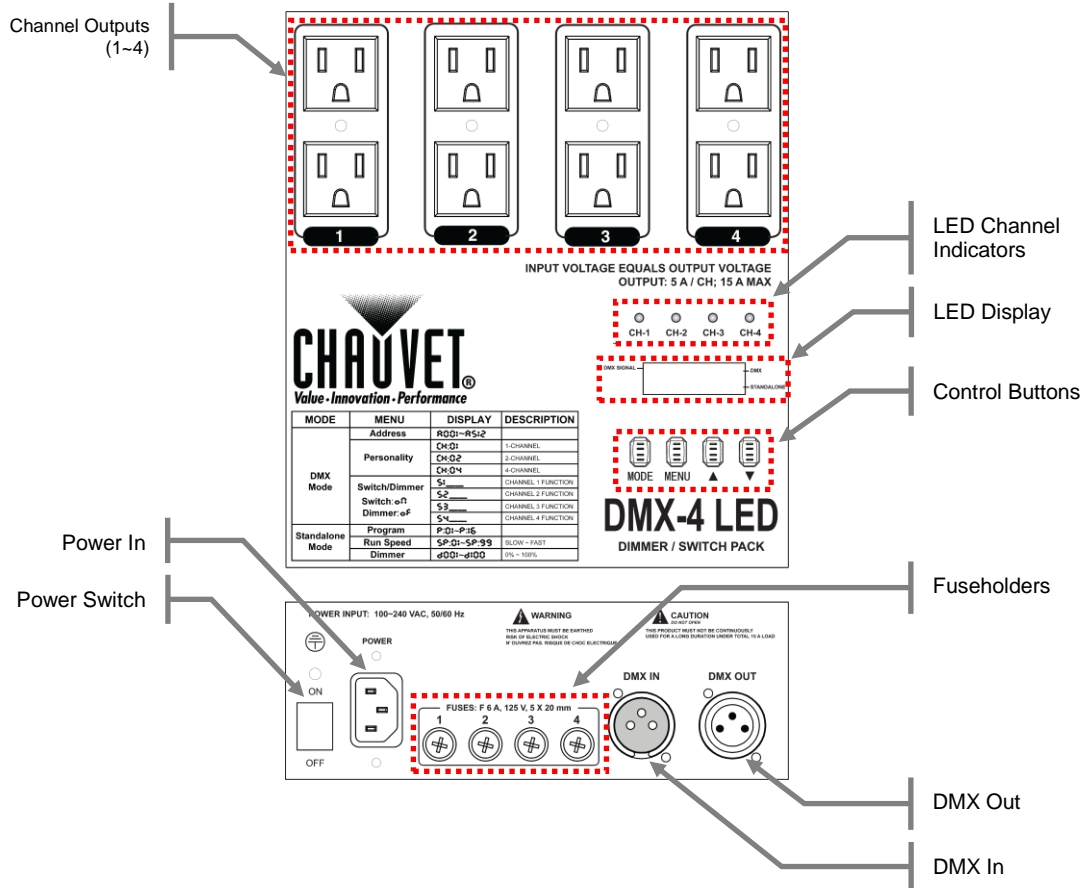

# 3. SETUP

## AC Power

This fixture accepts an input of 100~240 VAC, 50/60 Hz. Before powering on the unit, make sure the line voltage to which you are connecting it is within the range of accepted voltages. Also make sure that the fixtures you are plugging into the DMX-4 LED match the input voltage.

Input voltage equals output voltage.

To determine the power requirements for a particular fixture, see the label affixed to the back plate of the fixture or refer to the fixture's specifications chart. A fixture's listed current rating indicates its average current draw under normal conditions.



***Always connect the fixture to a switched circuit. Never connect the fixture to a rheostat (variable resistor) or dimmer circuit, even if the rheostat or dimmer channel is used only as a 0 to 100% switch.***



***Always connect the fixture to a circuit with a suitable electrical ground.***

## Notes on “Switch” Operation

Dimmer/switch packs are primarily intended for lamp-based PAR cans. Connecting a fixture equipped with an electronic (switching) power supply to a dimmer/pack switch may damage the fixture or make it work erratically.

The improved DMX-4 LED's design now allows you to switch on and off loads equipped with electronic power supplies, such as LED-based luminaries or laser fixtures. However, the DMX-4 LED must be in “switch” mode before connecting this type of loads to it. Please see the instructions on how to set the DMX-4 LED in switch mode below.



***Always make sure that the DMX-4 LED is in switch mode before connecting a load equipped with an electronic power supply to it. Doing otherwise could damage the load.***

## Changing between “Dimmer” and “Switch”

The DMX-4 LED has two different methods for controlling the output of the four (4) channels. This must be set by the user via the control panel.

Please see the steps below for this procedure.

1. Unplug any units from the four output channels.
2. Plug the DMX-4 LED into power.
3. Press **<MODE>** until **RD0 1-R5 12** appears on the LED display.
4. Press **<MENU>** until **5 1\*\*/52\*\*/53\*\*/54\*\*** appears on the LED display. This setting can be set differently for each of the four channels. Navigate to the desired channel.
5. Using **<UP>** & **<DOWN>**, select either **on** or **oF**. **on** switches the channel to “switch” method. **oF** sets it into dimmer method.
6. Continue to set this for each of the 4 channels, using the process detailed in the steps above, until complete.



## Rigging

The DMX-4 LED ships ready to mount a standard clamp directly to the mounting bracket. However, if you are using this product with truss or a lighting stand, then there is an alternate rigging configuration available. This option is ideal for hanging the product without using a hanging clamp.

Please see the steps below for further details.

1. Unplug power from the product.
2. On the back of the product, locate the six (6) Edison #2 screws.
3. Using a screwdriver, remove these.
4. The mounting bracket will now come off. Be careful not to damage the internal components of the dimmer, as they are exposed during this step!
5. Flip the mounting bracket (back panel) around.
6. Reattach the panel by securely installing the six (6) screws.

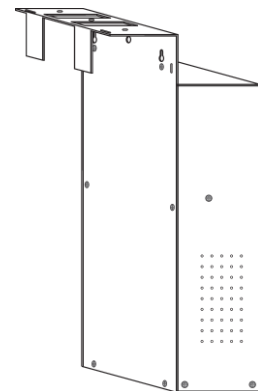
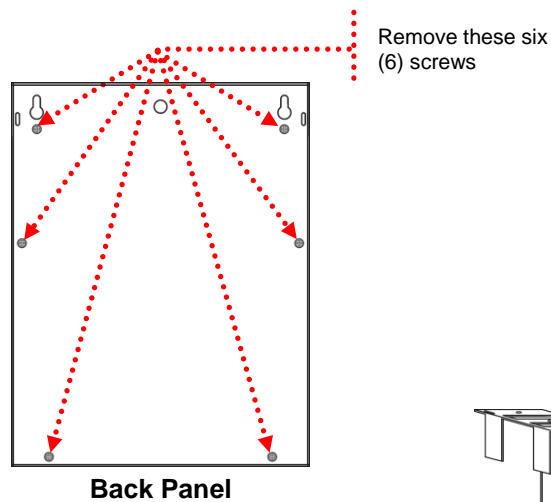



# 4. OPERATING INSTRUCTIONS

## Configuring the Starting Address

The DMX-4 LED fixture uses up to **four** DMX channels. The highest channel that the fixture may be set to in order to function properly is **509**. Any address higher than this will prevent access to all of the channels.

If this is your first time using DMX, we recommend reading the “DMX Primer” section in the “Appendix”.

## DMX Mode

This is the operating mode which will allow for control with an external DMX controller. You must set the starting address and personality for this mode.

Please see the instructions below.

1. Press **<MODE>** to switch between “DMX Mode” and “Standalone Mode”. Switch it to “DMX Mode”.
2. Press **<MENU>** until the LED display reads **CH=0 1~04**.
3. Using **<UP>** and **<DOWN>**, select one of the three personalities.
4. Press **<MENU>** until the LED display reads **A=00 1~A=5 12**.
5. Using **<UP>** and **<DOWN>**, select the DMX starting address.

## Standalone Mode

This fixture has built-in auto programs with adjustable settings.

Please see the instructions below.

1. Press **<MODE>** to switch between “DMX Mode” and “Standalone Mode”. Switch it to “Standalone Mode”.
2. Press **<MENU>** until the LED display reads **P=0 1~P= 16**.
3. Using **<UP>** and **<DOWN>**, select one of the programs.
4. Press **<MENU>** until the LED display reads **SP=0 1~SP=99**.
5. Using **<UP>** and **<DOWN>**, select the desired run speed.
6. Press **<MENU>** until the LED display reads **d=00 1~d= 100**.
7. Using **<UP>** and **<DOWN>**, select the desired dimmer level for the program currently running.

## Menu Map

MODE	MENU	DISPLAY	DESCRIPTION
DMX Mode	Starting address	<b>A00 1~A5 12</b>	
	Personality	<b>CH=0 1</b>	1-channel mode
		<b>CH=02</b>	2-channel mode
		<b>CH=04</b>	4-channel mode
	Switch/Dimmer	<b>5 1_</b>	Channel 1 function
		<b>52_</b>	Channel 2 function
		Switch: <b>on</b> Dimmer: <b>oF</b>	<b>53_</b>
<b>54_</b>		Channel 4 function	
Standalone Mode	Program	<b>P=0 1~P= 16</b>	
	Run speed	<b>SP=0 1~SP=99</b>	
	Dimmer	<b>d00 1~d 100</b>	Slow~fast

## DMX Channel Values

### 4-Channel Personality

In this DMX personality, the four channels will be controlled by separate DMX channels.

CHANNEL	VALUE	FUNCTION
1	000 ⇔ 255	<b>Dimmer</b> 0%~100%
2	000 ⇔ 255	<b>Dimmer</b> 0%~100%
3	000 ⇔ 255	<b>Dimmer</b> 0%~100%
4	000 ⇔ 255	<b>Dimmer</b> 0%~100%

### 2-Channel Personality

In this DMX personality, the four channels will be grouped into pairs. Channels 1+2 will be controlled by DMX channel 1, while channels 3 + 4 will be controlled by DMX channel 2.

CHANNEL	VALUE	FUNCTION
1	000 ⇔ 255	<b>Dimmer</b> 0%~100%
2	000 ⇔ 255	<b>Dimmer</b> 0%~100%

### 1-Channel Personality

In this DMX personality, the four channels will be grouped together. Channels 1+2+3+4 will all be controlled by DMX channel 1.

CHANNEL	VALUE	FUNCTION
1	000 ⇔ 255	<b>Dimmer</b> 0%~100%

# 5. APPENDIX

## General Troubleshooting

SYMPTOM	POSSIBLE CAUSE(S)	POSSIBLE ACTION(S)
Breaker/Fuse keeps blowing	<ul style="list-style-type: none"> <li>Excessive circuit load</li> <li>Short circuit along the power wires</li> </ul>	<ul style="list-style-type: none"> <li>Check total load placed on the electrical circuit.</li> <li>Check for a short in the electrical wiring (internal and/or external).</li> </ul>
Device does not power up	<ul style="list-style-type: none"> <li>No power</li> <li>Loose power cord</li> </ul>	<ul style="list-style-type: none"> <li>Check for power on Mains.</li> <li>Check power cord</li> </ul>
Fixture is not responding to DMX	<ul style="list-style-type: none"> <li>Wrong DMX addressing</li> <li>Damaged DMX cables</li> <li>Wrong polarity settings on the controller</li> <li>Loose DMX cables</li> <li>Faulty DMX interface</li> <li>Faulty Main PCB</li> </ul>	<ul style="list-style-type: none"> <li>Check Control Panel and unit addressing</li> <li>Check DMX cables</li> <li>Check polarity switch settings on the controller</li> <li>Check cable connections</li> <li>Replace DMX input</li> <li>Replace Main PCB</li> </ul>
Loss of signal	<ul style="list-style-type: none"> <li>Non DMX cables</li> <li>Bouncing signals</li> <li>Long cable / Low level signal</li> <li>Too many fixtures</li> <li>Interference from AC wires</li> </ul>	<ul style="list-style-type: none"> <li>Use only DMX compatible cables</li> <li>Install terminator as suggested.</li> <li>Install amplifier right after fixture with strong signal.</li> <li>Install an optically coupled DMX splitter after unit #32.</li> <li>Keep DMX cables separated from power cables or black lights.</li> </ul>



*If you still have a problem after trying the above solutions, please contact CHAUVET® Technical Support.*

## DMX Primer

There are 512 channels in a DMX connection. A fixture capable of receiving DMX will require one or a number of sequential channels. The user must assign a starting address on the fixture that indicates the first channel reserved in the controller. There are many different types of DMX controllable fixtures and they all may vary in the total number of channels required. Choosing a start address should be planned in advance. Channels should never overlap. If they do, this will result in erratic operation of the fixtures whose starting address is set incorrectly. You can however, control multiple fixtures of the same type using the same starting address as long as the intended result is that of unison movement or operation. In other words, the fixtures will all respond exactly the same.

DMX fixtures are designed to receive data through a daisy chain. A daisy chain connection is where the DATA OUT of one fixture connects to the DATA IN of the next fixture. The order in which the fixtures are connected is not important and has no effect on how a controller communicates to each fixture. Use an order that provides for the easiest and most direct cabling. Connect fixtures using shielded two conductor twisted pair DMX data cable with three pin XLR male to female connectors. The shield connection is pin 1, while pin 2 is Data Negative (S-) and pin 3 is Data positive (S+).

## Fixture Linking (Daisy Chain)

You will need a daisy chain to run light shows of one or more fixtures using a DMX controller or to run synchronized shows on two or more fixtures set to a master/slave operating mode. The combined number of channels required by all the fixtures on a daisy chain determines the number of fixtures the data link can support.



**To comply with the EIA-485 standard, do not connect more than 32 fixtures on one daisy chain. Connecting more than 32 fixtures on one daisy chain without the use of a DMX optically-isolated splitter may result in deterioration of the digital DMX signal.**

*Maximum recommended cable distance: 500 m (1640 ft)*

*Maximum recommended number of fixtures on a daisy chain: 32*

## Data Cabling

To link fixtures together you must obtain data cables. You can purchase CHAUVET® certified DMX cables directly from a dealer/distributor or construct your own cable. If you choose to create your own cable please use data-grade cables that can carry a high quality signal and are less prone to electromagnetic interference.

## DMX Data Cable

Use a Belden© 9841 or equivalent cable which meets the specifications for EIA RS-485 applications. Standard microphone cables cannot transmit DMX data reliably over long distances. The cable must have the following characteristics:

Type:	shielded, 2-conductor twisted pair
Maximum capacitance between conductors:	30 pF/ft
Maximum capacitance between conductor and shield:	55 pF/ft
Maximum resistance:	20 ohms/1000 ft
Nominal impedance:	100 ~ 140 ohms

## Cable Connectors

Cabling must have a male XLR connector on one end and a female XLR connector on the other end.

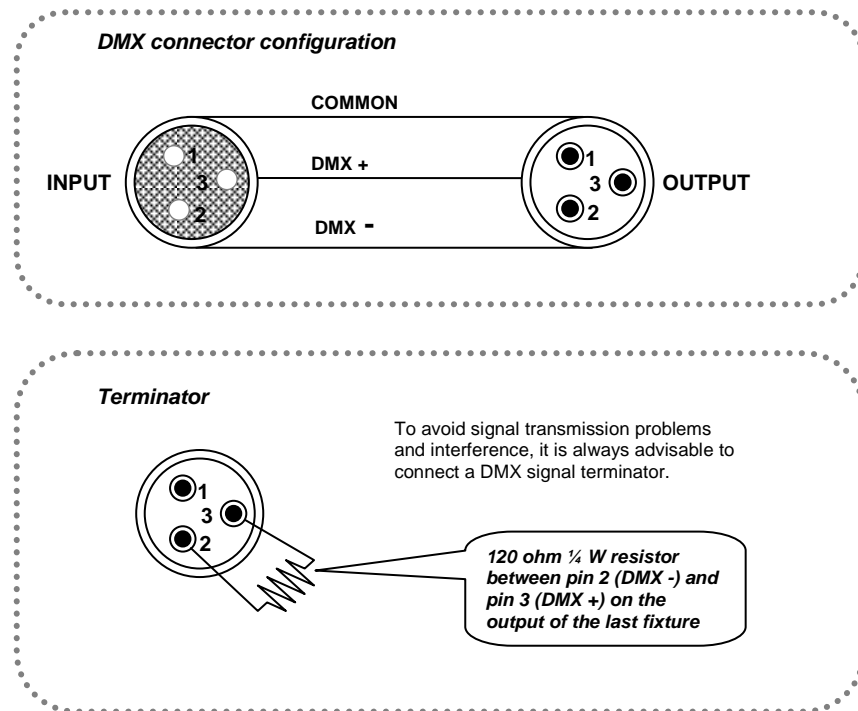

**Do not allow contact between the common and the fixture's chassis ground. Grounding the common can cause a ground loop, and your fixture may perform erratically. Test cables with an ohm meter to verify correct polarity and to make sure the pins are not grounded or shorted to the shield or each other.**

## Setting the Starting Address

This DMX mode enables the use of a universal DMX controller device. Each fixture requires a start address from 1~512. A fixture requiring one or more channels for control begins to read the data on the channel indicated by the start address. For example, a fixture that uses six DMX channels and was addressed to start on DMX channel 100, would read data from channels: 100, 101, 102, 103, 104, and 105. Choose start addresses so that the channels used do not overlap, and note the start address selected for future reference.

If this is your first time addressing a fixture using the DMX control protocol, we suggest jumping to the "Appendix" section and reading the heading "DMX Primer". It contains very useful information that will help you understand its use.

## 3-Pin to 5-Pin Conversion Chart



If you use a controller with a 5-pin DMX output connector, you will need to use a 5-pin to 3-pin adapter. The chart below details a proper cable conversion:

3-PIN TO 5-PIN CONVERSION CHART		
Conductor	3-Pin Female (Output)	5-Pin Male (Input)
Ground/Shield	Pin 1	Pin 1
Data ( - ) signal	Pin 2	Pin 2
Data ( + ) signal	Pin 3	Pin 3
Not used		Pin 4
Not used		Pin 5

## Setting up a DMX Daisy Chain

1. Connect the (male) 3-pin connector side of the DMX cable to the output (female) 3-pin connector of the controller.
2. Connect the end of the cable coming from the controller which will have a (female) 3-pin connector to the input connector of the next fixture consisting of a (male) 3-pin connector.
3. Then, proceed to connect from the output as stated above to the input of the following fixture and so on.

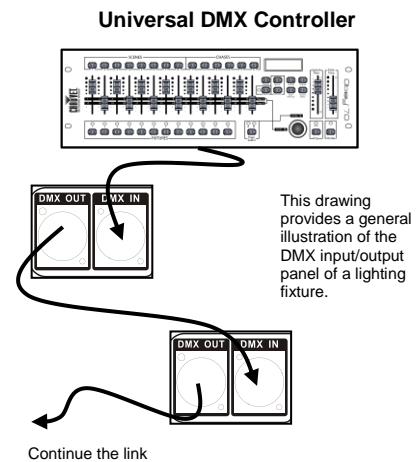

## General Maintenance

To maintain optimum performance and minimize wear, fixtures should be cleaned frequently. Usage and environment are contributing factors in determining frequency. As a general rule, fixtures should be cleaned at least twice a month. Dust build up reduces light output performance and can cause overheating. This can lead to reduced lamp life and increased mechanical wear. Be sure to power off fixture before conducting maintenance.

- Unplug fixture from power.
- Use a vacuum or air compressor and a soft brush to remove dust collected on external vents.
- Clean all lenses when the fixture is cool with a mild solution of glass cleaner or Isopropyl Alcohol and a soft lint free cotton cloth or lens tissue.
- Apply solution to the cloth or tissue and drag dirt and grime to the outside of the lens.
- Gently polish optical surfaces until they are free of haze and lint.



*Always dry the parts carefully after cleaning them.*



*Never spin a fan using compressed air.*

## Returns Procedure

Returned merchandise must be sent prepaid and in the original packing; call tags will not be issued. Package must be clearly labeled with a Return Merchandize Authorization Number (RMA #). Products returned without the RMA # will be refused. Call CHAUVET® and request an RMA # prior to shipping the fixture. Be prepared to provide the model number, serial number and a brief description of the cause for the return. Be sure to pack fixture properly; any shipping damage resulting from inadequate packaging is the customer's responsibility. As a suggestion, proper UPS packing or double-boxing is always a safe method to use. CHAUVET® reserves the right to use its own discretion to repair or replace product(s).



*If you are given an RMA #, please include the following information on a piece of paper inside the box:*

- 1) ***Your name***
- 2) ***Your address***
- 3) ***Your phone number***
- 4) ***The RMA #***
- 5) ***A brief description of the symptoms***

## Claims

Damage incurred in shipping is the responsibility of the shipper; therefore, the damage must be reported to the carrier upon receipt of merchandise. It is the customer's responsibility to notify and submit claims with the shipper in the event that a fixture is damaged due to shipping. Any other claim for items such as missing component/part, damage not related to shipping, and concealed damage, must be made within seven (7) days of receiving merchandise.

# TECHNICAL SPECIFICATIONS

## WEIGHT & DIMENSIONS

Length..... 8.3 in (210 mm)  
Width ..... 7.7 in (194 mm)  
Height ..... 2.8 in (70 mm)  
Weight ..... 5 lbs (2.2 kg)

## POWER

Input power ..... 100~240 VAC, 50/60 Hz  
Output voltage to fixtures ..... Input voltage equals output voltage  
Output current (max per channel)..... 5 A  
Output current (max total) ..... 15 A  
Fuse size ..... F 6 A, 250 V

## INDOOR/OUTDOOR

Rating ..... For indoor use only

## THERMAL

Maximum ambient temperature..... 104° F (40° C)

## CONTROL & PROGRAMMING

Data input ..... locking 3-pin XLR female socket  
Data output ..... locking 3-pin XLR male socket  
Data pin configuration ..... pin 1 shield, pin 2 (-), pin 3 (+)  
Protocol ..... DMX-512 USITT  
DMX Channels (user-configurable) ..... 1, 2, 4

## ORDERING INFORMATION

DMX-4 LED..... DMX4LED

## WARRANTY INFORMATION

Warranty ..... 2-year limited warranty

# CONTACT US

## WORLD WIDE

General Information ..... CHAUVET®  
5200 NW 108<sup>th</sup> Ave  
Sunrise, FL 33351  
voice: 954-929-1115  
fax: 954-929-5560  
toll free: 800-762-1084

Technical Support ..... CHAUVET®  
5200 NW 108<sup>th</sup> Ave  
Sunrise, FL 33351  
voice: 954-929-1115 (Press 4)  
fax: 954-929-5560 (Attention: Service)

World Wide Web ..... <http://www.chauvetlighting.com>